

**A SUPER-POWER RECEIVER BOOSTER FOR CB! P. 28**

**S9**

NOVEMBER 1965

50c

*the citizens band journal*



**GUIDE TO HOME CB SERVICING**  
**FCC FUNNIES**  
**MEET THE CAPACITOR**  
**WALKIE-TALKIE IN N. VIETNAM**  
**LIST OF WEATHER BUREAU RADIO STATIONS**  
**THE NO-HOOK SKY-HOOK**  
**MINIATURE VHF RECEIVER**

**The OFFICIAL CB RADIO MAGAZINE**

# The "Mariner" has arrived

way-out new five-element CB beam antenna . . .

works vertically or horizontally . . .

out-shouts them all with 12.5 db forward gain!

## M-134

FIVE ELEMENT BEAM ANTENNA

The "Mariner"

**Lightweight but tremendously rugged.** High quality aluminum construction that's reinforced with proper stress distribution to take winds up to 60 m.p.h. Weighs only 19 lbs.—easy to handle and install.

**Supplementary data:** The M-134 is Gamma fed . . . has 1.5/1 VSWR . . . and a boom length of just 22 ft.

**12.5 db vertical forward gain** (ref. flat ground plane) or 11.0 db in horizontal mode (ref.  $\frac{1}{2}$  wave dipole). Really booms your signal out where you want it.

**You get maximum rejection of unwanted noise** thanks to 20 db front-to-back ratio (vertical) or 25 db horizontal. It's like 10-2 from Mars!

See your a/s distributor today for complete specifications or write to:

Export Div.:  
64-14 Woodside Ave.,  
Woodside, N.Y. 11377

**the antenna  
specialists co.**

A div. of Anzac Industries, Inc.  
12435 Euclid Ave., Cleveland, Ohio 44106

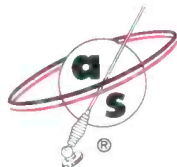

"Stripes of Quality"





# MODEL 660 CITIZENS

## RADIO TRANSCEIVER

The International Model 660 . . . new in styling . . . new in advanced technical features, combines space-age colors and decor with greater operating convenience.

Designed for base and mobile installations, the Model 660 provides instant push-to-talk operation on all 23 channels. Silicon transistors and tubes are combined in a new hybrid circuit for the highest degree of reliability.

A transistor power supply operates from 6/12 or 115 vac power sources.

See the International Model 660 at your dealer today. It comes complete with crystals, dynamic microphone with coil cord.

- Distinctive New Panel Design
- New Hybrid Circuits
- New Zener Speech Limiter
- Frequency Synthesized Crystal Controlled 23 Channel Operation
- Dual Conversion Receiver
- Illuminated Channel Selector Dial
- Ten Tubes
- Five Silicon Transistors
- Two Power Transistors
- Eleven Silicon Diodes

Write Today For The Name Of Your Nearest International Dealer.

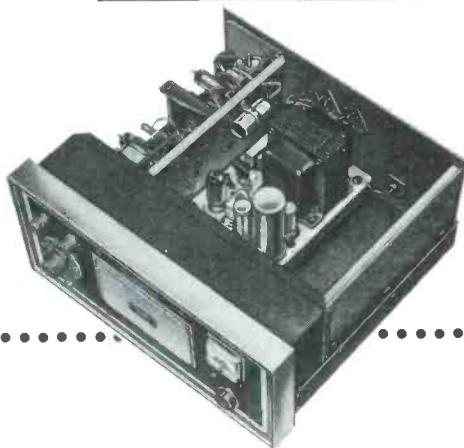

**CRYSTAL**  
MANUFACTURING CO., INC.  
18 N. Lee - Oklahoma City

FCC Citizens Radio license required. All use must conform with Part 95, FCC Rules and Regulations.



*the citizens band journal* 14 Vanderverter Ave., Port Washington, N. Y.

**FEATURES**

INSTANT FAME ..... Tom Kneitel, KBG4303 7  
 We really had a ball in Florida.

CHEAP SAM'S GUIDE TO HOME CB SERVICING ..... Sam Arshall, KFA1240 9  
 Save money, make your own repairs—easy tool!

FCC FUNNIES ..... Hank Miltenberg 12  
 Recent antics of the FCC'S monitoring squad.

MEET THE CAPACITOR ..... Gilbert Osmond, 1W3324 14  
 What makes 'em tick, and what they do for CB.

WALKIE-TALKIE, NORTH VIETNAM ..... William Graves, KK14118 21  
 Don't laugh at a little WT, they do a fine job.

CB 10-8! ..... Robert McAire, KIC7608 23  
 A visit to a CB emergency monitoring station.

LIST OF U.S. WEATHER BUREAU RADIO STATIONS ..... 25  
 For your emergency monitoring and SWL records.

THE NO-HOOK SKY-HOOK ..... Peter Dendin, 17W6366 27  
 A FREE antenna (well, almost FREE)!

BUILD THE "SUPREAMP" ..... Rod Hudson, 11Q5362 28  
 Watch this receiver booster go to town!

THE POCKET-CEIVER ..... General Electric 30  
 A miniature VHF receiver for monitoring.

"THERE WAS A CB'ER" ..... William Haymon, KBG5891 61  
 By now this is a tradition.

**DEPARTMENTS**

**EDITORIAL STAFF**

Reader Mail ..... 4

Editorial/Tom Kneitel, KBG4303 ..... 7

Kyle's Korner/Jim Kyle, KEG3382 ..... 32

On The Counters ..... 42

CB Chit Chat/John Krejc, KB18077 ..... 47

Antennas/Len Buckwalter, KBA4480 ..... 54

Suzie Sez/Susan Henriksen ..... 53

SWL Shack/Rick Slattery ..... 57

Card Swappers Unlimited ..... 62

Washington Outlook ..... 68

*editor* **Tom Kneitel, KBG4303**

*edit. assistant* **Lilia Neira, N-1812**

*asst. editor* **Susan Henriksen**

*club editor* **John Krejc, KB18077**

*contributing editor* **Lee Aurick, KCD5514**

*part 15 editor* **Dean Detton, N-17**

*contributing editor* **Jim Kyle, KEG3382**

**BUSINESS STAFF**

*adv. representative* **Dick Cowan**

*adv. representative* **Jack Schneider, KMD3272**

*circul. mgr.* **Hal Weisner, KBG4528**

*publ. consultant* **David Saltman**

S9 (title registered U.S. Post Office) is published monthly by Cowan Publishing Corp. Executive, editorial and advertising offices at 14 Vanderverter Avenue Port Washington, L. I., N. Y. 11050 Telephone: (516) PO 7-9080  
Subscription Rates: One year \$5.00, two years \$9.00, three years \$13.00 in United States and Possessions, APO, FPO, and Canada.

Printed in U.S.A. Entire contents copyright 1965 by Cowan Publishing Corp. S9 does not assume responsibility for unsolicited manuscripts. We regard all material sent to us in CB club publications as being intended for publication in S9 as a public relations gesture of the club. We cannot pay for the use of this public relations material, although we do pay for editorial material which is specifically written for us and accepted for publication.

Controlled Circulation Postage Paid at New York, N. Y.

**POSTMASTER: SEND FORM 3579 TO: S9, 14 Vanderverter Ave., Port Washington, L. I., N. Y. 11050.**



# Be super-critical.

Whether you're looking for the fun and economy of building quality kits or you want ready-to-use factory-wired equipment — before you buy, examine carefully. Compare

EICO with anybody else — feature for feature, chassis for chassis, part for part. The more critical you are, the more you'll see for yourself that your best buy is EICO.



Over 3,000,000 EICO instruments now in use! Preferred by engineers, scientists, technicians and students. EICO equipment is available nation-wide through 2500 EICO dealers.

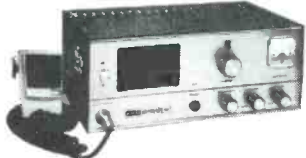

**New Model 779 — Sentinel 23 CB Transceiver.** 23-channel frequency synthesizer provides crystal-controlled transmit and receive on all 23 channels. No additional crystals to buy ever! Features include dual conversion, illuminated S/R/F meter, adjustable squelch and noise limiter, TV filter, 117VAC and 12VDC transistorized dual power supply. Also serves as 3.5 watt P.A. system. \$169.95 wired.



**New Model 712 — Sentinel 12 Dual Conversion 5-watt CB Transceiver.** Permits 12-channel crystal-controlled transmit and receive, plus 23-channel tunable receive. Incorporates adjustable squelch & noise limiter, & switches for 3.5 watt P.A. use, spotting, & Part 15 operation. Transistorized 12VDC & 117VAC dual power supply. \$99.95 wired only.

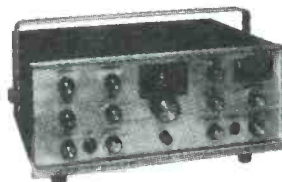

**New Model 753 — The one and only SSB/AM/CW Tri-Band Transceiver Kit.** 200 watts PEP on 80, 40 and 20 meters. Receiver offset tuning, built-in VOX, high level dynamic ALC. Unequaled performance, features and appearance. Sensationally priced at \$179.95 kit, \$299.95 wired.



**New Model 440 Scope.** Lowest-priced quality oscilloscope available. Excellent for electronics teaching and home workshop. Flat 2c-500kc. 3" flat-face new CRT. Compact, light, rugged. \$49.95 kit, \$69.95 wired.

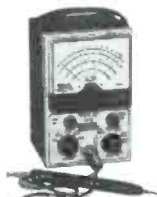

**Model 232 Peak-to-Peak VTVM.** A must for color or B & W TV and industrial use. 7 non-skip ranges on all 4 functions. With Uni-Probe. \$29.95 kit, \$49.95 wired.



**Model 324 RF Signal Generator.** 150kc to 435mc range. For IF-RF alignment and signal tracing of TV, FM, AM, CB and mobile. Built-in and ext. modulation. \$28.95 kit, \$39.95 wired.



**Model 667 Tube/Transistor Tester.** Dynamic conductance tube tester. 14 combinations of 3 plate and 3 screen voltages and 3 ranges of grid voltage. Interleaved leakage readings in ohms. Checks all new tube types. Two step transistor test. \$79.95 kit, \$129.95 wired.

**Model 628 Emission Tube Tester.** Checks all new tube types. \$44.95 kit, \$59.95 wired.



**Model 460 5" Oscilloscope.** DC wideband 0-4.5mc for color and B & W TV service and lab use. Push-pull DC vertical amp., bal. or unbal. input. Automatic sync limiter and amp. \$89.95 kit, \$129.95 wired.



**Model 1064 DC Power Supply.** For bench testing auto radios, CB, mobile and tone equipment. Voltmeter and ammeter. Low ripple for transistor equipment. 0-8V/0-16V outputs. \$45.95 kit, \$54.95 wired.



**New Model 3566 — All Solid-State Automatic FM MPX Stereo Tuner/Amplifier.** No tubes, not even novistors. Delivers 112 watts IHF total to 4 ohms, 75 watts to 8 ohms. Completely pre-wired and pre-aligned RF, IF and MPX circuitry, plus plug-in transistor sockets. \$219.95 kit, \$325.00 wired with cabinet.

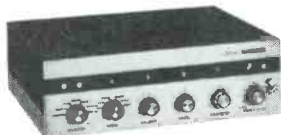

**Model ST70 70-Watt Integrated Stereo Amplifier.** Best buy of highest ranked stereo amplifiers according to independent testing. \$99.95 kit, \$149.95 wired. ST40 40-Watt Integrated Stereo Amplifier, \$79.95 kit, \$129.95 wired. ST97 Matching FM MPX Stereo Tuner, \$89.95 kit, \$139.95 wired.

**EICO Electronic Instrument Co., Inc.** S9 11  
131-01 39th Ave., Flushing, N. Y. 11352

Send for FREE catalog describing the full EICO line of 200 best buys and name of nearest dealer. I'm interested in:

- test equipment
- hi-fi
- ham radio
- CB

Name \_\_\_\_\_

Address \_\_\_\_\_

City \_\_\_\_\_

State \_\_\_\_\_ Zip \_\_\_\_\_

1945-1965: TWENTY YEARS OF LEADERSHIP IN CREATIVE ELECTRONICS

S9 = more news, more authors, more value!

November 1965 • 3

# READER MAIL

## COMMENT: CONGRESSMAN BOW

Dear Fellow CB'ers:

This copy of "The CB Splatter," official publication of the Citizens Band Association of Jackson County, Inc., is sent to you so that you may see the True Copy of an article taken from the August issue of S9.

May I say that our members have undertaken a letter-writing campaign to our various Congressional representatives in support of Congressman Bow's Resolution [August issue, page 9]—also letters have been sent to Congressman Oren Harris who is the Chairman of the House Foreign and Interstate Commerce Committee in support of the Resolution.

May I suggest that, in the next possible issue of S9, an appeal be made to CB'ers to send *one QSL card ONLY* showing their name and address and Call Sign and a message supporting House Resolution 377 to:

Hon. Oren Harris, M.C.

Chairman

House Foreign & Interstate Commerce Committee

House Office Building

Washington, D.C. 20006

Perhaps if enough CB'ers send cards, the Congressman will realize how widespread CB'ing is today and, will support the Resolution.

Edward L. Field, KEB1659  
Gautier, Miss.

Dear Editor:

I am a shortwave listener of four years and hold the monitoring call of WPE0CGV. I recently read in S9 an article by Congressman Frank Bow which made me quite angry. In it he claimed that the 10 meter band is not particularly useful to the Amateur Radio Service. What more do you CB'ers want? You had a band on UHF and then you decide that you want the 11 meter band and you got it. You now have 800,000 licenses on it and you cry that you need more room! If you would get about 799,999 of these "lids" off the band you'd never complain. Has it ever occurred that the 10 meter band might still be enjoyed by some hams? Six meters has skip. Two meters has the novices. So what if so many CB'ers have expensive equipment and a crowded band? If they have any desire for lobbying, let them study for a ham license and then convert their CB gear to 10 meters. Don't forget that hams have good money in their equipment too. Just don't go getting any ideas on the 10 meter band.

Kenneth C. Lemke, WPE0CGV  
Wisner, Nebraska

Get your facts straight, Ken. The FCC plucked 11 meters away from the Hams on their own decision—CB'ers had absolutely no say in the matter. There were no Class D CB'ers to even ask for this band when it was taken away from the Hams. The Class B CB'ers on UHF didn't comprise enough operators to fill a telephone booth. It strikes me that you are a proponent of the "dog in the manger" school of thought—just because the Hams had the 10 meter band first they should be allowed to hold on to it. Makes no difference that they seldom use it. Makes no difference that almost one million other operators can use it. Say, where were you when the Hams took 10 meters away from whoever had it before them? Where were you when the TV stations, with their rigged quiz shows, 10 foot tall washing machines and white tornadoes, took over some 487 megacycles worth of spectrum space (that's the size of 1873 citizens bands, by the way)? Did you know that scientists had to battle for several years to get back a few piddling shreds of this TV spectrum so that they could continue important radio astronomy

work there? Let's see copies of the letters you wrote supporting radio research into outer space. Oh well, some people never learn.

## CLUB QUERY

Tom:

What's your opinion of the NCBRA Association? Since there are several national organizations for CB'ers, is this one any better than the others? Will it do the job for my \$9?

Kent Radcliff, KNH0020  
Dexter, Kansas

*It'll sure do the job for your \$9, but we can't tell you what they can do for YOU. So far we haven't seen any of these national clubs do anything which is worth 9¢ for their members. One of the fellows at Electronics Illustrated Magazine told me that they will be running a behind-the-scenes look at so-called "national CB clubs" in their January, 1966, issue.*

## FROM A SWAPPER

Dear Tom:

What do you do with all those cards you get from the card swappers' section?

Tony Russomanno, KKE0173  
Whippany, N. J.

*They get thrown into a big carton and handed out to any needy looking CB'ers who show up at the office and ask for them. In addition, we will send them out to any subscriber who furnishes us with a stamped, self addressed envelope—put two or three 5¢ stamps on the envelope and we'll try to stuff it with as many cards as will fit. If we happen to be out of cards temporarily, we'll hang on to your envelope until the supply replenishes. The cards are free. Address your requests to: Free QSL's, S9 Magazine, 14 Vanderveer Avenue, Port Washington, N. Y. 11050. Don't forget to include the subscription number (from the address strip on your copy of S9) when writing.*

## CITIZEN BANDER?

Gentlemen:

I have heard from several people that President Johnson has a CB license. Is this true or false? If it's true, what are his call letters?

Steven G. Gibson, KKK8237/WN6QBH  
Northridge, Calif.

*Judging from the FCC's harsh treatment of CB, including the revised rules, under the Johnson administration, we can assume either one of two possibilities. First, President Johnson never heard of CB. Or, second, he is an active CB'er who got tired of "breakers." Seriously, we haven't heard this one yet—so anybody out there who has any confirmation on this, please let us know.*

## WOW!

Tom:

Just a short note to let you know what a tremendous response that small picture and writing in the August S9 on the card swappers page has produced. I have received and answered 1334 QSL cards to date and they are still coming in.

Just thought you would like to know.

Robert L. Ruyle, KG13471  
Field Engineer  
Hy-Gain Electronics Corp.  
Lincoln, Nebr.

## HALLICRAFTERS' SIDE

Dear Mr. Kneitel:

Your editorial [August S9, page 7] completely overlooks the most important aspect of type accepted prod-

*Continued on page 71*

*The BIG Difference in  
Citizens Band Units is...*

**JOHNSON'S**

**UNMATCHED  
RELIABILITY!**

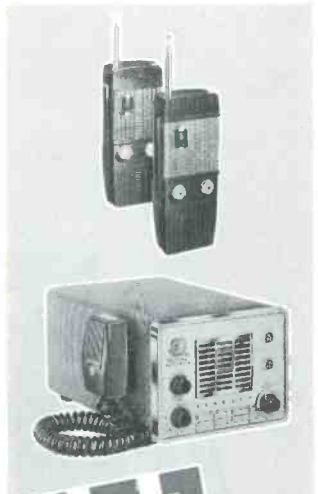
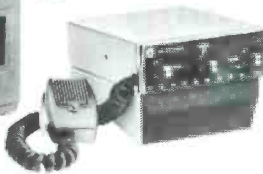

For personal or business use, no other equipment equals the day-in day-out dependability of Johnson "Messenger" Two-Way Radios. "Messengers" are designed to deliver maximum performance, even under extreme operating conditions. Before you buy—take a long look at the Johnson quality line—or better yet, talk to any "Messenger" owner. You'll see why dollar for dollar, Johnson is your best buy! Easy to install, easy to operate, license issued on request.

*See your nearest  
Johnson Dealer/Distributor  
or write for complete information.*



**E. F. JOHNSON COMPANY**  
WASECA, MINN. 56093 • 7052 TENTH AVE. S.W.



## The Browning Raven is something to rave about!

Everybody's talking about the new Raven CB mobile unit. And no wonder! Browning has come up with a real gem that not only looks good but delivers absolutely the finest performance you can get in modern CB circles. This little giant is only 4" high by 10 3/4" wide by 8" deep. It has 23-channel crystal control transmit and receive. For super-quiet operation, there's a new noise limiter and for superior sensitivity there's a dual Nuvistor front end. And talk about good looks . . . the Raven has a black leatherette exterior and a recessed front panel in brushed chrome satin finish. See it now at your franchised Browning Service Center. Buy it and you'll rave about the Raven, too.

Please send me literature and price information on the Raven CB mobile unit.

NAME \_\_\_\_\_

ADDRESS \_\_\_\_\_

CITY \_\_\_\_\_ STATE \_\_\_\_\_ ZIP \_\_\_\_\_

CALL LETTERS \_\_\_\_\_

S-9



**browning**  
LABORATORIES, INC.

1269 UNION AVENUE, LACONIA, N. H. 03246



editorial

# KBG4303 rides again!

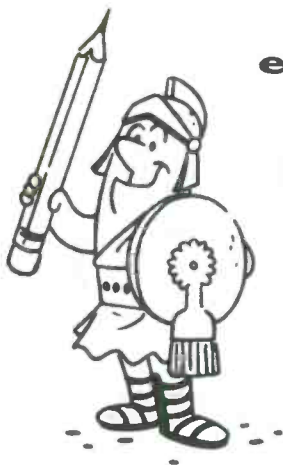

by TOM KNEITEL  
EDITOR, S9

## CAPE KENNEDY REPORT

Last month I briefly thanked the Cape Canaveral CB Club for presenting S9 with a beautiful award for public service, because the issue was just about on the presses when the award was being given to us at the Florida National CB Jamboree.

Were you at the jamboree? If you didn't make it, you really goofed, because in addition to participating in one of the very best CB events we have ever seen, we were also treated to the happy coincidence of being on hand to get a first hand view of the Gemini 5 space shot.

Hugh Pinney, 7Q0523, Jamboree Chairman, pulled a few strings somewhere along the line and was able to get a few of us right into the Kennedy Space Center—even into places which are regularly closed to the public.

The jamboree itself began on Friday, August 20th, and really rocked along until Sunday P.M. We were very pleased to get a chance to meet so many of our readers—especially interesting chats were held with regular S9'ers like Miami's "Sugar" and Ed Lander, KMP2038, Barney Ross of Washington, D.C., Woody Gallatin of McCoy AFB, Florida, Pat Flynn, KKP3015, of Orlando, Fla., and Nick Miller, KDJ0332.

Among the interesting sidelights on the Florida trip were: the gal who sings torch songs at a place called "The Mousetrap" in Cocoa Beach. Her name is Julie Peterson and she's worth a special trip to the Cape just to dig her. We also enjoyed racing a borrowed E-Jag along the sands at Daytona early one A.M. (we *didn't* get caught by the Sheriff Department's Tom Ruger, KDH0742, a regular S9 reader). When you're in Florida next, take a run along route 250, just east of the junction with route 50 at Bithlo—look for a place called Rocket City, one of the hundreds of real estate developments which dot the state. From the road it seems to be a twentieth century ghost town—all buildings seem to be relatively new, *but deserted!* This includes a vacant shopping center which is overgrown with



Vince Larson, KD10450, Veep of the Cape Canaveral CB Club, on the left, presents yours truly with the spiffy plaque. Photo by Hugh Pinney, 7Q0523.

tall grass and weeds, likewise a motel, plus about two dozen homes—none of which looked as if they were ever occupied. By the way, on route 250, between Rocket City and Cocoa there is a small sign announcing that a "Radar Speed Check" is ahead—if you take route 250 be careful, they really have a hidden radar trap operating much of the time. Despite the advance warning sign we saw a number of drivers snagged by the fuzz.

## COMPLAINT DEPARTMENT

We keep a little memo pad which lists the most frequently heard complaints about S9. When I took a running total the other day I was sort of shocked to notice that the most frequently recorded squawk was about what we call "run-back" or "back yard" in S9. This is the placing of the last few paragraphs of an article in the rear of the issue. Apparently most people who complained about this feel that this is done just to cause confusion. It isn't.

*Continued on page 70*

# New from RCA!

# ALL SOLID-STATE CB 2-WAY RADIO WITH ALL SILICON TRANSISTORS



New RCA Mark 10 Transistorized CB Radio

only \$189<sup>95</sup>\*

Here's the latest, and the finest, in a long line of exceptional 2-way radios from RCA. The new all transistor RCA MARK 10 with the operating features you have been asking for...engineered to provide the most dependable communications possible. Check this partial list of RCA MARK 10 advantages:

- All silicon transistors assure dependable communications at temperatures ranging from  $-23^{\circ}$  to  $+130^{\circ}$ F.
- 12 crystal-controlled transmit and receive channels with illuminated channel selector
- Combination "S" meter and relative RF output meter
- Operates from 12-volts DC power source (positive or negative ground)
- 3-watt public address system with volume level fully controllable by receiver volume control
- Provision for tunable receive, AC operation, and external speaker (optional)
- Crystal-controlled double conversion, superheterodyne receiver provides frequency accuracies greater than 0.004%

- Separate AGC amplifier eliminates blasting and overloading, minimizes fading
- Six-stage IF bandpass filter for maximum selectivity without ringing
- Low distortion, series type noise limiter with automatic threshold adjustment
- Receiver power regulated for maximum stability
- Acoustically designed cabinet with audio characteristics shaped for maximum intelligibility
- External speaker jack (de-activates internal speaker)
- Compact, lightweight. Only 3 $\frac{3}{8}$ " high, 5 $\frac{3}{4}$ " deep, 8 $\frac{1}{2}$ " wide, weighs less than 4 $\frac{1}{2}$  pounds

See it at your Authorized RCA Citizens' Band Radio Distributor. To find him, look for stores displaying this symbol. It's your assurance of top-quality RCA CB equipment.

\*Optional distributor resale price



RCA ELECTRONIC COMPONENTS AND DEVICES, HARRISON, N. J.



The Most Trusted Name in Electronics

The one thing that grabs me most is to see good money being unnecessarily spent. From experience, I have found that a great many of the repairs required on CB equipment can be very easily accomplished by even the most rank novice—and done with household tools and other assorted junk from around the CB shack. While, needless to say, there are a number of repairs on CB gear which should be performed by an experienced (and FCC licensed) service specialist, it is sheer folly to have these people spend their expensive time doing something which you, yourself could have taken care of in a few minutes time.

I have therefore made up a list of some of the more frequent simple complaints I have noted with CB gear, together with some suggestions on how you can squelch the problems.

Let us begin by stating that you should always have a manual for your rig at your station—or at the very least, a schematic. If the manual which came with your set is lost, then write to the manufacturer for another one.

*Problem: Set is completely dead—tubes don't even light.*



## CHEAP SAM'S GUIDE TO HOME CB SERVICING

**EVEN IF YOU ARE WITHOUT TOOLS, EVEN IF YOU HAVE NO RADIO EXPERIENCE, YOU CAN STILL PERFORM MOST OF THE BASIC MAINTENANCE AND REPAIR WORK ON YOUR CB GEAR—ALL BY YOURSELF!**

by SAM ARSHALL, KFA1240

**Try:** Making sure that the unit is connected to the power line or car battery. Frequently a plug is knocked from the wall by accident, and it's not even thought of as a possible reason for the equipment failure. If the set is connected to the power source, check the fuse to see if it has blown. Check the connections of the wires going to the plug in the wall from the set—perhaps they are broken or the connections have come loose. Wiggle the power plug at the power connections at the rear of the chassis. If all of this still produces no results, go inside the rear of the CB rig and find the rectifier tube in the power supply—your schematic should pinpoint the tube quickly. Chances are that it will be a tube with a type number containing a letter from "W" through "Z" in the alphabet, and located near the power transformer.

Wiggle the tube around in the socket, while the set is plugged in and still turned on. Check this tube on a tube tester if results are not forthcoming.

*Problem: Set lights up, but received signals are very weak.*

**Try:** Checking the coaxial connector to make certain it is connected to the set. If it is connected, check to see that the cable hasn't been pulled loose from its connections in the plug. Possibly the connections on the other end of the cable, at the antenna, have come loose—or have *corroded* loose! If these things check out, then check the tubes in the IF section and also the RF amplifier tube. If they are all lit, then tap them (lightly) a few times with the eraser end of a wooden pencil. Any tube which causes the set to improve when tapped means a tube which

needs replacing. This failing, remove these tubes from the set and have them checked on a tube tester.

*Problem: Set lights up, but no sound.*

Try: Checking the speaker leads. If they are connected, then adjust the volume control back and forth a few times. If the sound cuts in and out when you do this, take some *Injectoral Tuner Cleaner* and squirt it into the control (unplug the set when doing this).

Check all of the tubes associated with the audio section of the rig—first by tapping and then, if needed, on a tube checker.

Check to make certain that the T/R relay is functioning properly.

*Problem: "Ringing" sound from loudspeaker, set has feedback when volume is turned up.*

Try: Looking for a microphonic tube. This is easily accomplished by the pencil tap test. Start in the IF section.

*Problem: Station at other end of contact tells you that you have a signal, but no modulation.*

Try: Checking the connections inside of the microphone connector—one may have come loose. Check out the tube(s) in the audio circuit, as these are frequently used for double-duty in the modulation circuit. This failing, try another microphone.

*Problem: Station on other end tells you that there is a hum or buzz on your modulation.*

Try: Looking at the electrolytic capacitors in your set for a defective one. If nothing seems to be leaking out of any of them, you'll have to give up and take the set to someone who can find the bad one with test equipment. Check audio tubes.

*Problem: You hear a hum or buzz on stations being received.*

Try: Looking for a defective electrolytic capacitor as previously described. That producing no results, look for a loose connection which should be going to ground—or a connection going to ground which doesn't belong there. Test tubes in audio and RF sections.

*Problem: All received signals are distorted in quality.*

Try: Looking to see if the loudspeaker is still intact—perhaps the paper cone has become torn or the speaker connections are loose. Check the tubes in the audio section of the rig, also all tubes in the IF circuits.

*Problem: Sound from set has a "scratchy" quality, especially when volume is adjusted.*

Try: Giving the volume control a few squirts of *Injectoral Tuner Cleaner*, or similar products.

*Problem: Set "motorboats," that is, gives off a "putt-putt" sound from loudspeaker.*

Try: Looking for an electrolytic capacitor going on the fritz.

*Problem: Constant crackling sound from loudspeaker, usually accompanied by sharply fluctuating signal strength.*

Try: Look for a bad connection in the antenna or coaxial cable. Could be that one of the antenna elements is loose.

These ideas should solve many of the major complaints which you will come across in normal CB'ing, but there are other maintenance steps which you should take to keep the set perking along at an acceptable peak.

For instance, from time to time, remove the set from its cabinet and use a vacuum cleaner to clean out the dust. Remove all of the tubes and stick the vacuum cleaner nozzle into each tube socket, also into the plates of the tuning capacitor (be careful not to knock it against the capacitor plates so as to bend them). Shoot *Tuner Cleaner* fluid into all controls and into the relay. Do not do any fooling around with screwdriver adjustments on IF cans or anywhere else. Check beneath the set to see that all connections are still intact.

When you replace the tubes, be certain that they are all going back into their proper sockets. It might be a good idea to mark the appropriate tube type in grease pencil next to each socket.

## THE ANTENNA

Your ol' sky hook can cause you a lot more problems, if its neglected, than you might imagine—besides smothering your signal, it can cut into incoming signals and also make quite an awful racket in your receiver.

Periodic lowering and inspection of the antenna is always advisable, and should you live within a few miles of the sea, this inspection is mandatory at least once or twice a year. Salt corrosion can really put the whammy on your antenna.

When you get your antenna down, take it apart—that's right—I said *completely* dismantle it as if you had just taken it out of the carton! If you have trouble getting any of the screws or nuts and bolts apart (many manufacturers give you a fancy, non-rusting antenna for which they supply connecting hardware which rusts almost immediately), get a can of a product called *Liquid Wrench* and squirt it onto the stuck screws or nuts. *Liquid Wrench* is made by the Radiator Specialty Company of Charlotte, N. C. and it's sold in most hardware stores—it eats through rust and corrosion in nothing flat. Rusted bolts and parts are then easily taken apart.

With a fine sandpaper (or SOS soap pads—even *Brillo*), give all of the antenna elements a going over to free them of oxidation, grit, grime, soot, salt, rust, etc. Don't forget that while antennas don't rust, they do corrode and oxidize eventually. Squirt some of your *Injectoral* tuner cleaning juice around the portion of the antenna where the coaxial cable is attached, then wipe thoroughly with a bath towel to get it clean. You might give the whole antenna a coat of

*Continued on page 69*



# NEW Heathkit® All-Transistor 23 Channel 5-Watt CB Transceiver



Kit <b>\$89<sup>95</sup></b> <small>(LESS AC POWER SUPPLY SHOWN)</small>	Factory Assembled <b>\$124<sup>95</sup></b>
--	--

**Transceiver Kit & 46 Crystals . . . \$169.90!**

- ★ 23 crystal-controlled transmit & receive channels
- ★ 14 transistor, 6 diode circuit for cool, instant operation and low battery drain—.75 A transmit, .12 A receive
- ★ Full 5 watt performance . . . minimum of 3 watts RF output, plus 3 watts audio modulating power
- ★ Front panel "S" meter indicates signal strength & relative power output . . . aids in alignment
- ★ Adjustable squelch control eliminates speaker hiss during standby
- ★ Automatic noise limiter minimizes noise from ignition systems, electric motors, etc.
- ★ ½ uv sensitivity for 10 db signal plus noise to noise ratio
- ★ Built-in PM speaker
- ★ Easy to build with circuit board construction
- ★ Attractive TURNER ceramic PTT microphone
- ★ Handsome die-cast, chrome-plated front panel with rust-resistant aluminum charcoal gray cabinet
- ★ Includes power cables & crystals for 1 channel (Specify) and gimbal mount for versatile installation
- ★ Base mount AC power supply for "fixed" station available soon

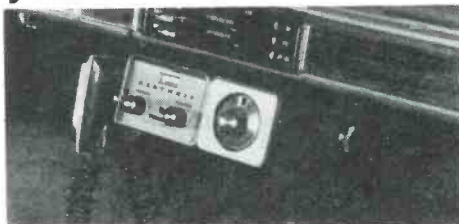

**Compact "Fit-Anywhere" Size!**

Only 2½" H x 7" W x 10½" D . . . ideal for car, boat, jeep, tractor, any mobile installation.

**Complete 23-Channel CB Crystal Pack . . . \$79.95!**

Regular \$135.70 value! 46 transmit & receive crystals for complete GW-14 operation. Order GWA-14-2, 1 lb.

**4 Money-Saving Reasons To Buy Heathkit CB!**

1. New Lower Prices On All Units
2. 5% Discount On Any Two 5-Watt Unit Buy
3. New Lowest Cost All-Transistor 5-Watt Transceiver . . . Kit Or Wired!
4. Lowest Crystal Prices . . . \$1.99 Each With Order Of One Or More Transceivers!

Kit GW-14, 8 lbs. . . . .	<b>\$89.95</b>
Assembled GWW-14, 9 lbs. . . . .	<b>\$124.95</b>
Kit GWA-14-1 AC Power Supply for "fixed" station operation . . . . .	<b>\$14.95</b>

FCC license required. Use must comply with Part 95 FCC Regulations.

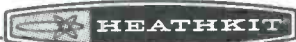

## NEW!

**Free 1966 Catalog**

108 pages . . . many in full color . . . describe these and over 250 easy-to-build Heathkits. Save up to 50%. Mail coupon for your FREE copy.

Heath Company, Dept. 43-11 Benton Harbor, Michigan 49023  
In Canada: Daystrom, Ltd., Cooksville, Ontario

Enclosed is \$ \_\_\_\_\_, plus postage.

Please send model(s) \_\_\_\_\_

Please send FREE 1966 Heathkit Catalog

Name \_\_\_\_\_

Address \_\_\_\_\_

City \_\_\_\_\_ State \_\_\_\_\_ Zip \_\_\_\_\_

Prices & Specifications subject to change without notice.

GX-142R

# FCC

# FUNNIES

## RECENT ACTIONS OF THE FCC'S MONITORING SQUAD

by HANK MILTENBERG

Seattle postal authorities, resorting to radio in an effort to trap a person suspected of using the mails for extortion, unexpectedly found themselves playing before an appreciative TV audience. The viewers, realizing that they were getting an unscheduled "live" show, hurried to the post office to see its climax. It did not materialize because the wary suspect failed to linger. Later investigation by engineers of the local FCC office determined that it was another case of inadequate frequency selectivity in local TV receivers. They picked up an adjacent Government frequency. It was suggested that the post office use a different frequency, one well removed from any TV channel serving the locality.

Three weeks of intermittent hoax radio messages reporting about vessels in "distress" on Chesapeake Bay were ended when the FCC Baltimore, Md., engineering office cooperated with other agencies concerned in tracing the calls to two teen-age boys operating an unlicensed transmitter on a pleasure boat. Many manhours of combined effort, including use of mobile units and a helicopter, were required to trace the fake alarms. The latter asked assistance for mythical boating accidents which, on several occasions, sent rescue vessels on fruitless missions. The boys—aged 13 and 14—even asked the Coast Guard for instructions about berthing an imaginary "U.S.S. HONOLULU." The boys were released in the custody of their parents pending possible further action.

Complaints of interference to TV reception in a California community were traced to a neighboring miniature auto speedway. Here it was found that the toy racing cars, electrically operated, were not keeping to their guided tracks as far as radiation was concerned. The operator was notified but failed to take steps to comply with the law on incidental radiation devices. The FCC had to institute formal proceedings.

While en route to Cincinnati on a routine inspection trip, an engineer from the FCC Detroit field office noticed that the driver of a car in back of him was taking an unusual interest in the FCC vehicle. When the other car finally drove by, the FCC engineer noted a citizens radio call sign and unit number displayed in the rear window. Aware of the many instances of illegal transfer of operating authority, the FCC engineer copied the identifications for later check. The driver, observing this activity via his rear-view mirror, pulled off the road and motioned for

the FCC car to stop. With QSL card in hand, he introduced himself. He became somewhat red-faced when the engineer produced his own identification card and asked for the usual license information. It developed that the other was using an authorized call. The chagrined operator returned to his car remarking: "I didn't know you guys also had road patrols!"

When a Russian jet airliner carrying 51 passengers made an unscheduled landing at Kennedy Airport, N. Y., for emergency refuelling, it was not known generally that the FCC had been tracking its flight by long-range direction finders for more than three hours after it swung away from its direct course to Havana, Cuba. The Commission's monitoring system participates routinely in air and sea emergency operations so that search and rescue craft can be speeded to distress scenes. FCC monitoring stations from Maine to Florida joined in this particular emergency alert.

While roaming an amateur band, one "ham" heard an emergency call. It was very weak and suddenly left the air. However, he did note the call sign. Wanting to be of assistance, the amateur contacted the FCC watch officer in Washington, D.C. Identifying the call sign as that of an amateur in Lynn, Ind., the watch officer suggested that the Indiana highway patrol be notified. Result: The latter found the licensee and his family trapped inside their house trailer which had been overturned by high winds during a storm. All were rescued uninjured.

The FCC received complaints from military bases extending from New York to Georgia and Texas about obscene and venomous language—verbally and in Morse code—on the MARS (Military Amateur Radio Service) frequencies. FCC monitoring fixed the obnoxious transmissions as originating near Bridgeport, Ohio. They were then tracked to a particular house. There FBI agents arrested a 32-year-old man operating a home transmitter. Although he had threatened over the air to shoot anyone who came after him, he offered no resistance. He faces Federal prosecution for which conviction could bring a maximum penalty of two years in prison or a \$10,000 fine, or both. The FBI commended FCC monitoring for locating the offender.

A Naval officer at Annapolis, Md., while listening in on his amateur set, heard a fellow "ham" report twin tornadoes striking Coldwater, Mich., before the call was disrupted. He alerted the

FCC Baltimore field office which, in turn, got first word to the sheriff of the county in which the city was located. This enabled that official to take necessary actions.

An Air Force base advised the FCC Philadelphia field office that it was receiving interference on a frequency used for job control and aircraft maintenance. When FCC investigative engineers arrived at the base, security control was so strict that each was assigned an escort. The first visit was fruitless because the offending signal was on only briefly. But on the second trip the FCC men were able to pin the cause on a transmitter-receiver previously okayed by commercial maintenance contractors. The base ordered replacement of the defective unit.

Engineers from the FCC Los Angeles district office were called upon to determine the cause of black and white dots on complainants' TV receivers in that city. Comparative signal strength measurements pointed to several local dwellings, but most of the occupants were reluctant to admit or talk to strangers. Eventually, with the aid of a portable TV receiver with rotatable dipole antenna, the annoying signals were traced to the home of one of the complainants. Under questioning, he revealed that he had a radio-controlled garage-door opener but insisted that it had been unplugged. Search revealed that the garage-door motor only had been disconnected while the associated radio receiver remained operative and radiated interference. It, too, was removed from service.

Radio station antennas are required to be

painted orange and white for easier air safety detection. However, an FCC engineer from the Detroit district office found one tower belonging to an industrial radio station in Michigan that was freshly painted bright yellow and blue. The licensee explained that the mast had needed repainting and that he had hired some traveling tower painters to do the job. When he questioned them about the colors they were using, they replied that they were painting according to the "newest standards." Told that the color scheme had not changed, the licensee agreed to have the tower repainted to conform with requirements.

**S9**

## CLUBS-TEAMS-SCHOOLS SAVE MONEY

BUY FROM MANUFACTURER

Emblems • T-Shirts • Sweatshirts • Lettering  
Banners • Jackets • Award Ribbons • Pennants

**FREE PRICE QUOTATIONS...** SEND SAMPLE OR SKETCH.

State Name Of Club - Team - School

Send 35c For Catalog and Assorted Emblems.

*American Knitwear and Emblem*  
PLAISTOW 14, N.H.

## CRYSTALS are not all the same!

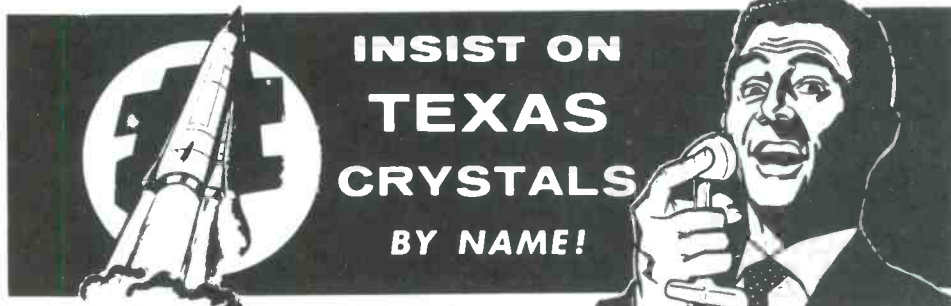

**INSIST ON  
TEXAS  
CRYSTALS  
BY NAME!**



TEXAS CRYSTALS quality is outstanding as evidenced by use in numerous government space projects where there's no compromise with quality, reliability or accuracy. The same dependable performance is yours for CB operation on all 23 channels at only \$2.95 per crystal.

If your dealer is temporarily out of stock or does not carry Texas Crystals, send us his name along with your order. Minimum order, check or C.O.D. is \$5.00. Add 5¢ per crystal for postage, 10¢ for air mail.

Send for Free Catalog with Circuits

## TEXAS CRYSTALS

1000 Crystal Drive  
Fort Myers, Florida 33901  
Phone 813 — WE 6-2109

4117 W. Jefferson Blvd.  
Los Angeles, California 90016  
Phone 213 — 731-2258

A Division of Whitehall Electronics Corp.

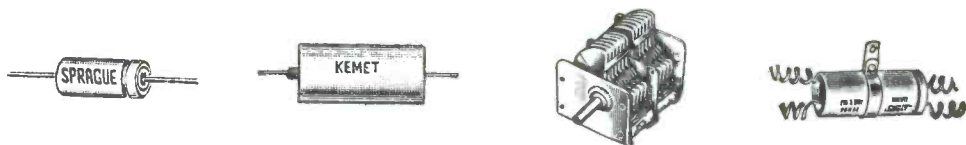

# Meet the Capacitor

by GILBERT OSMOND, 1W3324

**IF THE RELATIVE MERITS AND CHARACTERISTICS OF MICA, CERAMIC, AND PAPER CAPACITORS HAVE SEEMED A BIT OBSCURE, YOU'LL FIND IT WORTHWHILE TO READ THIS. THE CONSTRUCTION, CHARACTERISTICS, AND USES OF CAPACITORS ARE SET FORTH IN DETAIL.**

In a previous article on components,<sup>1</sup> resistors of various types were discussed in detail to acquaint the CB'er with some of the varied manufactured types, their features and respective nomenclature systems. This article will cover the more familiar varieties of mica, ceramic, and paper capacitors that are most frequently used in low-voltage circuitry. An attempt has been made to introduce only those pertinent facts which will aid an experimenter in choosing the best possible capacitor for every normal application.

The physics of a capacitor or condenser—call it what you will—are well known. Any pair of electrical conductors having their surfaces relatively close together and separated by a dielectric (insulating) material forms a capacitor that will store electrical charge when a difference in potential is applied across them. When the conductors are in the form of parallel plates, close together and of large area, the capacity of the capacitor is given by the formula:

$$C = 2.25 \frac{KA}{t} \times 10^{-7} \text{ microfarads}$$

where:

K = Dielectric Constant

A = Area of one side of either plate, sq. in.

t = Spacing between plates, in.

(1 microfarad =  $1 \times 10^{-6}$  Farads)

This familiar equation shows that the capacity is directly proportional to the area and the dielectric constant and inversely proportional to the spacing between plates. The dielectric constant is defined as the ratio of the capacitance of a

capacitor using a specific dielectric material to the capacitance of the same capacitor having a vacuum as the dielectric. Obviously, a capacitor may be increased in capacity either by decreasing the spacing or by increasing the area of the plates or the dielectric constant.

## TEMPERATURE AND VOLTAGE CHARACTERISTICS

Since space is of paramount importance in most electronic equipment, it would seem at first glance that capacitors might very well have minute spacings between plates to achieve large capacities in small "packages"; however, voltage breakdown possibilities between plates must be considered. To prevent voltage arcing between plates, any dielectric material must of necessity have good "dielectric strength" if small spacings and high capacities are to be achieved.

The actual materials used for dielectrics in practical fixed capacitors vary in dielectric constant from about 7 for mica to several thousand for certain ceramics. For the same physical dimensions, a high dielectric capacitor may have many hundred times the capacity of a mechanically similar mica unit, although the former may *not* maintain a constant capacity over wide ambient temperature changes. The "temperature coefficient of capacitance" or the change in capacity with temperature, generally becomes worse as the dielectric constant K increases.

There are some ceramic dielectrics containing the mineral rutile which exhibit certain useful temperature coefficients. These substances, when mixed in certain proportions, have negative temperature coefficients (capacity varies inversely

1. Osmond, Gilbert, "Meet the Resistor," S9, October, 1965.



with the temperature) when  $K$  is larger than 21, zero when  $K = 21$ , and positive coefficients when  $K$  is less than 21. A coefficient is usually expressed as a certain number of parts per million parts per ° Centigrade ( $p/m/° C$ ) in temperature and is preceded by a sign indicating positive or negative characteristic. Thus, a 100 microfarad capacitor having a temperature coefficient of  $-220$  parts/million/° C will decrease in capacity  $0.022$  micromicrofarads ( $\mu\mu f$ ) per degree Centigrade increase in temperature, and vice versa. The calculation is done as follows:

$$\Delta C = \frac{100 \times 10^{-12} \times (-220)}{10^6 \text{ } ^\circ C} = -0.22 \times 10^{-12} \text{ farads/} ^\circ C = -0.22 \mu\mu f/^\circ C$$

Such a capacitor might very well be used in some critically tuned circuit where a decrease in capacitance with increasing temperature is needed associated inductor due to heating of the wire.

Mica finds greatest use as a dielectric material when excellent capacitance stability over wide ranges of temperature is expected. In smaller capacity values, generally those under  $200 \mu\mu f$ , zero coefficient ceramic units are capable of performing equally well. Unfortunately, small size zero coefficient ceramic capacitors cannot readily be made having capacity values exceeding several hundred  $\mu\mu f$ , since they are essentially single layer capacitors while mica units invariably consist of many layers of alternate conductor plates and mica dielectric sheets.

### POWER FACTORS

A perfect capacitor would hold a charge infinitely and thus would have zero per cent power factor. That is, the impressed AC voltage would lead the current through the capacitor by precisely  $90^\circ$ . In practice, however, this is not quite the case. Dielectrics are never absolutely perfect insulators, and further, some corona and leakage resistance effects are always present in varying degrees depending upon the types. A word of caution is in order concerning high quality capacitors of large capacity values. These items may hold a death-dealing charge for long periods of time, and care must be taken to prevent accidental contact with both plates or terminals unless they are first shorted together through a small current limiting resistor.

When using a capacitor in a VHF tuned circuit, it is most desirable to use one having the best possible power factor, i.e. the lowest in per cent, if high  $Q$  is to be maintained. At 1 megacycle, mica and certain ceramic capacitors have power factors of about  $0.02\%$  a figure which insures excellent circuit performance.

It should be mentioned that power factor worsens with increasing frequency, and that, at higher frequencies, increasing lead and contact resistances of the capacitor also tend to add additional circuit losses.

Ordinary mica capacitors are made by piling up alternate sheets of copper foil and mica, after which external leads are connected to the correct internal jumpers between sheets. By plating the sheets or the mica itself with a thin film of pure

silver, the over-all resistance of the capacitor may be appreciably reduced with a noticeable gain in high frequency performance. These capacitors are known as "silver micas" and are available at extra cost. Ceramic condensers, on the other hand, are usually made by spraying silver paint on opposite sides of a ceramic dielectric, after which the silver is firmly bonded by firing at high temperatures. Thus, these components have inherently good power factor, excellent mechanical stability, and are also extremely suitable for very high frequency applications.

In the discussion which follows, mica and ceramic capacitors will be treated individually with emphasis on the selection of the correct type for an application. Some notes on paper capacitors will also be introduced.

### MICA CAPACITORS

Mica capacitors find use in circuits where a high order of stability is desired. Depending upon the quality of a particular capacitor, the temperature coefficient of capacitance will vary from about  $\pm 200$  parts/million/° C for the average good varieties to  $0$  to  $-50$   $p/m/^\circ C$  for the best available. The size increases very appreciably as the temperature coefficient requirements are tightened; however, this is common with ceramics as well. Long time capacitance stability of the mica capacitor appreciably betters as the temperature coefficient of capacitance is reduced, since the greater volume used tends to nullify temperature effects.



Small micas from  $6,200 \mu\mu f$  down are rated at  $500$  DC working volts, while those above have  $300$ -volt ratings. These figures apply only to the small receiving types, since it is possible to obtain micas in larger cases for almost any working voltage desired. The voltage ratings for AC depend upon the frequency involved. A particular  $1,000 \mu\mu f$  mica capacitor rated at  $10,000$  volts at  $1$  kilocycle, for example, has a breakdown voltage of only  $178$  volts at  $10$  megacycles, a fact often overlooked.<sup>2</sup>

The minimum value generally available for micas is  $5 \mu\mu f$  while the maximum for small receiving types is  $10,000 \mu\mu f$  or  $0.01 \mu f$ . This wide range is sufficient to meet most r.f. and audio requirements; however, when smaller values are necessary, recourse to ceramics will provide capacity values down to  $0.5 \mu\mu f$ . Paper capacitors, not hermetically sealed, are made in values up to  $0.25 \mu f$  or so, with hermetically sealed papers, high quality oils and electrolytics going very much higher. It must be emphasized that these are only approximate ranges, inasmuch as new

2. Terman, "Radio Engineers' Handbook," p. 126, McGraw Hill, N. Y.

developments in capacitors are constantly expanding the scope of each type.

Mica capacitors are therefore recommended whenever the circuit at hand requires a stable, high  $Q$  (or low-loss), component of comparatively close tolerance. Resonant circuits, time constant charging circuits, and critical coupling applications are typical examples. For non-critical by-pass and coupling usage, it is economically more advantageous to utilize the high- $K$  ceramics or paper capacitors.

### CERAMIC CAPACITORS

Ceramic capacitors may be broken into two general types. There are those having comparatively low dielectric constants with correspondingly low capacities, and there are those having extremely high  $K$ s.



The lower- $K$  capacitors are ideal for all rigorous circuitry requirements, in particular those requiring temperature compensation. Ten different temperature coefficients of capacitance are usually manufactured in the small values from 0.75  $\mu\text{mf}$  to 300  $\mu\text{mf}$  or so, the number decreasing as the capacity increases. As with mica capacitors, it is difficult to obtain large capacities with zero temperature coefficient in small physical sizes, the maximum Joint-Army-Navy (JAN) zero coefficient component being 360  $\mu\text{mf}$  in a 2"-long tubular case. The coefficients generally standardized upon range from + 100 through 0 to - 750 p/m/ $^{\circ}$  C, with cost decreasing in the same order. Tolerances for most range from 1 to 20% for values from 27 to 1,600  $\mu\text{mf}$ . Smaller values have slightly looser tolerances due to the difficulties in measuring such minute capacities. Ceramics are available in all values cased in insulated bodies or in the form of uninsulated tubes.

High- $K$  capacitors provide the greatest capacities in the smallest space of all presently available receiving type capacitors. Although they suffer from poor temperature characteristics and are available only in comparatively poor tolerances, they are unexcelled for all general coupling and by-pass needs due to their lower cost and their small size. Capacitors of this type are available in the form of dime-size wafer-thin discs in values up to 10,000  $\mu\text{mf}$ . These capacitors are rated at 500 volts or so for DC. All low- $K$  capacitors are rated at 500 volts DC. Both types must be "de-rated" in the same manner as micas when AC operation is contemplated at the higher frequencies. It should be mentioned that the high- $K$  varieties are unsuitable for use in resonant circuits, since their stability is unpredictable and since tolerances are so wide by comparison to low- $K$  versions that precise frequency control will be impossible.

### PAPER CAPACITORS

Paper capacitors are almost universally used when circuit requirements call for 10,000  $\mu\text{mf}$  or more, since large micas are not available. In low cost equipments, they are often used in smaller values, although it appears that high- $K$  ceramics will displace them in such usage. These components are made by rolling alternate strips of aluminum foil and specially treated chemically pure paper into tube-like shapes. The foil, when correctly brought out to two terminals, forms the plates which are separated by the dielectric paper. The assembly is packaged into paper or plastic tubes and rectangular cases, both types being very common. Better versions use two or three strips of one to two mil (1 mil = 1/1,000 inch) paper bonded together as the dielectric, while inexpensive varieties depend upon but one layer of one mil material. As is usual in engineering work, a compromise must be made with size and relative security against voltage breakdown versus a smaller, less expensive component.



With one layer of paper dielectric, 200 volts DC is the order of working voltage, while two- and three-layer capacitors can be relied upon at higher working voltages. Irrespective of the number of layers, it is absolutely necessary to keep moisture from collecting in the pores of the paper dielectric. Water will destroy these capacitors in a very short time, hence the unusual precautions to keep the innards of these components absolutely dry. Unfortunately, it is almost impossible to keep moisture from creeping in along the space, minute as it may seem, between the flexible leads and the body of the case. In military and good commercial equipment, all paper capacitors are hermetically sealed in metal cases to guard against this danger. The familiar "bathtubs" are paper capacitors having almost indefinite life when properly used within their voltage and temperature ratings.

Tolerances on paper capacitors are generally poorer than micas and ceramics of the low- $K$  type, since the thickness of the paper dielectric cannot be maintained constant with any degree of precision. The paper itself is a poor dielectric at any but audio frequencies, thus limiting these capacitors to by-pass and coupling circuits. As mentioned previously, maximum operating temperatures must not be exceeded, otherwise premature failures will certainly occur. But despite these disadvantages, paper capacitors are almost universally used and will be until a superior type is devised. When correctly chosen for the application at hand, they will be relatively trouble-free. A 100% safety factor in working voltage rating is excellent assurance of long life dependability!

**S9**

**\*se·lec·tive** (sĭ lĕk'tĭv) *adj.*  
 having the function or power  
 of selecting; making selectio  
 characterized by selection. I  
*Radio.* having good selectivity  
 of being . . . 2. *Elect.*  
 ins . . . like, by vi



## \*CONTACT! - 23

### AT LAST! SELECTIVITY THAT REALLY SELECTS!

The Contact!-23 has achieved exceptional selectivity through the use of a true Mechanical Bandpass Filter — similar to that found in far more expensive ham equipment.

### AND THERE'S LOTS MORE TO THE CONTACT!-23

You get crystal control on all 23 channels, both Transmit and Receive, via a synthesized circuit — all crystals included.

- Illuminated, angled front panel
- Built-in speech compressor
- Fine tuning
- Illuminated S & RF meter
- Modulation indicator
- Transistorized power supply, 12V and 110V
- Cigar lighter plug-in
- Electronic switching
- Earphone jack
- PA system jack

Complete with: microphone, cords and snap lock mounting brackets.

**USL CONTACT!-23 \$19950**



**USL CONTACT!-8 \$14950**

Illuminated, angled front panel. 23-Ch. tunable receiver with illuminated dial. 8-Ch. crystal-controlled transmit & receive. 1-Ch. external crystal socket—transmit & receive. Transistorized power supply. Illuminated S & RF meter. Crystal spotting. Electronic switching. PA system jack. Complete with: microphone, cords, 1 pr. of crystals and snap lock mounting brackets. Cigar lighter plug-in, easy to install. Nuvistor low noise front end.

**USL T 1050 A \$11995**



23-Ch. tunable receiver with illuminated dial. 6-Ch. crystal-controlled transmit & receive. Illuminated S & RF meter. Crystal spotting. Earphone jack. Nuvistor low noise RF front end. 6V or 12V power supply available (optional extra). Unit comes complete with: microphone, AC cord, 1 pr. of crystals and mobile mounting brackets. Squelch & full series noise limiter. TVI trap. Signal-to-noise ratio: better than 10 db at 1 microvolt. Full plate modulation.



**UNITED SCIENTIFIC LABORATORIES, (KKD5719)**

Division of Vernitron Corporation

475 Union Ave., Westbury, L. I., New York

Dealership inquiries invited

HEY GANG!

БУДУ

HOY!

מיניא נאוו!

ACHTUNG!

AHORA

Whoopie!

UNBELIEVABLE

מיניא נאוו!

FINALLY!

# The GIANT 1965-1966 Who's Who in CB Directory

It's finally on the presses, the big, giant, fantabulous, ever lovin' WHO'S WHO IN CB DIRECTORY 1965-66! Yes, the vital statistics on every "In" CB'er on the band; hundreds upon hundreds of listings showing callsigns, names, addresses, telephone numbers, monitoring channels, club affiliations, hobbies, ham calls, etc., also a personal message from almost every CB'er listed especially for you. This rare first edition (a limited print run), containing over 1500 listings, will shortly be mailed out to those CB'ers who have reserved their copies.

How and when do you reserve a copy? You do it NOW! You do it by filling out the form at the bottom of this page and returning it to our office with your remittance. How much? Well, if you are listed in the Directory (having filled out a form from a previous issue and sent it in), the \$1 which you sent in for your listing is deductible from the \$2 cost of the book, and you have only to send in an additional \$1 to receive your copy. If you aren't listed, the price is \$2, postpaid. Dealer inquiries are invited. So send that order in now, we don't know how long the supply will last.

Only \$2\*

postpaid N.Y.S. Residents please add 2% state sales tax.



\* \$1 directory listing fee is deductible for those CB'ers listed in the book.

Who's Who In CB Directory 1965-66  
% Cowan Publishing Corp.  
14 Vanderventer Avenue  
Port Washington, N. Y. 11050

Name: \_\_\_\_\_ CB Call \_\_\_\_\_  
Address: \_\_\_\_\_  
City \_\_\_\_\_, State: \_\_\_\_\_, Zip: \_\_\_\_\_

I enclose \$ \_\_\_\_\_ for \_\_\_\_\_ copy(ies) of Who's Who in CB. I \_\_\_\_\_ am \_\_\_\_\_ am not listed in this Directory.



# WALKIE-TALKIE NORTH VIETNAM

**DON'T LAUGH AT THE LITTLE HAND HELD UNIT!**

by **WILLIAM S. GRAVES, KKI4118**

(ON DUTY IN VIETNAM)

This is the story of a naval aviator, shot down in communist North Vietnam, and how he owes his life to a small hand-held, transistorized walkie-talkie.

"That's a handy piece of communications gear," said Townsend after his rescue. Coming from him, this could well be the classic understatement to come out of the Vietnam war.

Townsend, 27, of West Palm Beach, Florida, had just unloaded his bombs on a couple of bridges about 65 miles north of the 17th parallel in North Vietnam. He had turned his jet A4 Skyhawk toward home — the Seventh Fleet carrier USS Midway.

"Suddenly there was a terrific explosion and I could feel the aircraft going out of control," Townsend later told his debriefers. He was forced to eject and found himself drifting down onto a hillside deep in communist territory.

Beneath him were buildings and unfriendly forces. Above him circled two A1 Skyraiders — his buddies from the Midway.

Townsend landed in thick grass which was as tall as the 6 foot 2 aviator. He knew he was on a hill, but could not see anything because of this thick grass.

He immediately shed his parachute and flight gear and began to move up the hill, but going was rough. Stopping to rest, he pulled out his walkie-talkie and attempted to establish contact with the Navy planes overhead.

He was told a rescue helicopter was on the way and that the propeller driven A1's would stay with him until he was safely on his way home.

"I talked on the radio every few minutes just to hear a friendly voice," Townsend said. "Sort of like having company."

Then he heard shouts and the sound of people moving through the undergrowth.

"See anybody coming up the hill?" Townsend anxiously asked his airborne shipmates. "Nope, not from here," came the reply.

"Well I can hear them. How about making a strafing run down this hill below where I am," Townsend asked.

"Roger," said the A1 pilot.

And so it went for an hour or so. Townsend calling for fire protection while he sat on the



hillside awaiting rescue with only his walkie-talkie for company.

He then began to smell smoke and heard the unmistakable sound of fire moving through grass. "Is there a fire down there," he asked on his walkie-talkie.

"Sure is," came the reply.

Thinking that his would-be captors had started the fire in an attempt to smoke him out, Townsend asked hopefully, "Did you guys start that fire with your rockets?"

"Afraid so," was the curt though comforting answer from the pilot above. "And it appears to be coming your way."

At that point the downed aviator did not have time to voice his concern as he heard the "whop,

*Continued on page 70*

**Shape up with the  
sharp one!**



## ***XL-100 C. B. Mobile Brand-new from TRAM***

So sharp, adjacent channel rejection is 95 db or better! TRAM achieves this SUPER-SELECTIVITY with a built-in crystal filter. This, Better-Than-The-Competition excellence, separates TRAM's XL-100 from all others in the field.

Take a fast look at just some of the quality features that make TRAM Number One with pros who know!

23 channel operation via synthesis. • Compact (main unit 4" x 8" x 8"). • Sensitivity second to none. • Selectivity that can't be matched in any standard unit. • Built-in low-pass filter, minimizes "T.V. I.". • Hand wiring. • Teflon covered wire. • Locking switch makes rig tamper-proof. • Set padlocks to dash bracket. • Heavy duty, commercial microphone. • High efficiency transmitter. TRAM delivers 3.5 watts minimum output to the antenna. That's really getting your 5 watts worth of power.

At \$318 TRAM's XL-100 is your best C. B. value . . . your best TRANSCEIVER buy!

Write for FREE ILLUSTRATED BROCHURE  
(name of nearest TRAM dealer)

All use must conform with Part 95 F.C.C. regulations. Hobby type communication or aimless small talk prohibited.

**XL**  
**TRAM L 100**

Quality at Your Finger Tips

**TRAM ELECTRONICS, INC.**

Dept. No. A-11, P.O. Box 187, Lower Bay Rd., Winnisquam, N. H., Phone 603-524-0622



# CB 10-8!

## A VISIT TO A TYPICAL CB EMERGENCY MONITORING STATION

by ROBERT McAIRE, KIC7608

Setting up emergency monitoring stations seems to be the current trend with public spirit minded CB clubs—what with HELP, REACT, and other emergency programs being established.

Want to see how easy it is to whip together an emergency monitoring station? It really is, you know. Here's a typical set up, just as might be established by your very own club. With it, the following bands may be monitored: "High Band" (152 to 173 mc/s), "Low Band" (30 to 50 mc/s), and the aircraft band (110 to 136 mc/s). All three sets are run from only one antenna, with a switch governing the set which is to be connected to the antenna.

On the roof we have one of the new Lafayette 40-0105 "Range Boost" antennas; this is a ground plane which has its ground radials cut for 30 to 50 mc/s and the radiating element doing double duty on both high band and low band by means of a matching transformer which makes it a quarter wave on low band and a colinear array on the high band—somehow or other the "mid-band" aircraft frequencies seem to also work out quite well, probably because of their proximity to the high band frequencies. A 50 ohm coaxial cable does a fine job of bringing the RF down to the receivers. Since the antenna is used for receiving only, there is no height restriction applicable from the FCC. This particular installation was atop two 6 foot lengths of steel pipe, topped off by two 5 foot lengths of aluminum tubing, 23 feet in all. masting is supported by standard TV antenna wall brackets. It should be noted that on the instruction sheet which comes packed with the antenna, the unit is referred to as a CB antenna—although it isn't listed as such in the Lafayette catalogue. We haven't tried it out on CB to see how it loads up.

Inside the shack we have a Regency Monitoradio MR-10 for high band, a Regency Flight Monitoradio AR-136 for aero, and a Lafayette HA-50 for low band—all three are top notch megacycle inhalers and we recommend each heartily. The tendency of some VHF monitor

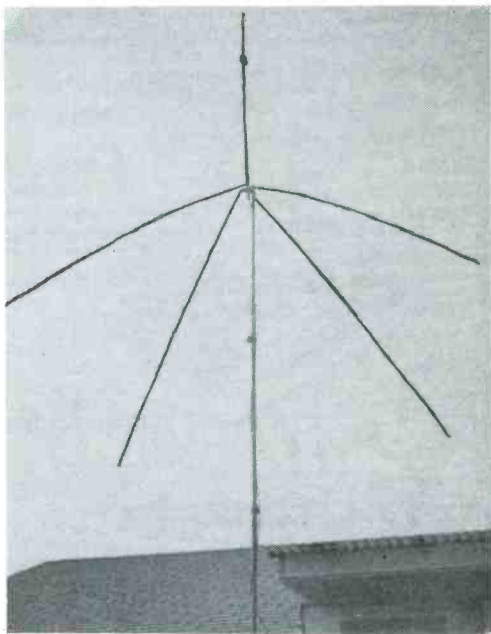

receivers to have microphonics and to receive image signals has not been noted in any of these three particular receivers. Calibration, another weak point of some VHF monitor sets, is also quite accurate in these three units. Hallicrafters, Squires-Sanders and Hammarlund also produce nice VHF monitor gear.

The antenna inputs of all three sets are of the 50 ohm variety, with screw terminals, rather than SO-239 coaxial connectors. We ran all three sets to an International Crystal type 100-112 coaxial switch which has one input (for the antenna) and three outputs (one for each receiver). Actually, the local police station is so strong that an antenna was not really a necessity on either the high band or on the low band set (the sheriff uses this band in my area). The antenna is normally left hooked to the aircraft receiver,

*Continued on page 69*

# READERS' BONANZA!

TAKE YOUR PICK OF THESE GIFTS!

For some time now we have been offering all kinds of free goodies with new subscriptions and renewals, we vary them each month. But we always seem to get requests for bonus items which haven't been offered for several months and that sends the Circulation Department into a tailspin. So here it is, a grand round-up of all the various offers, tied in with an exciting offer for you to get several of these things FREE with your subscription or renewal.

BONUS ITEM #1 — Large 3 inch, 3 color, "Monitor Channel 9" decal. Regularly sells for 50¢.

BONUS ITEM #2 — 50 Project Aid cards which you are required to use to notify the FCC whenever you use your CB rig to help a stranded motorist or for any emergency use. These sell for \$1.00.

BONUS ITEM #3 — Membership in the Association to Condemn Detrimental Associations (ACDA), now the world's largest do-nothing CB club. No officers, no program, it was patterned after one of the so-called "national" CB clubs. You get a big red and gold certificate for your wall with this one.

BONUS ITEM #4 — Do-It-Yaursell-S9-Editor-Kit — Yes, an official multicolored S9 Press Card which will get you on buses (show it when you pay your fare), also a 10-code card, plus one of our now famous green and white "Wall Certificates."

BONUS ITEM #5 — Jazzy blue-with-white, red-with-white or black-with-white plastic badge engraved with your callsign. Big 1" high by 3" long. Just the thing for a jamboree or use the pin to stab artichoke hearts or your aunt Maud in the clyde. \$1.50 value. Specify color combination.

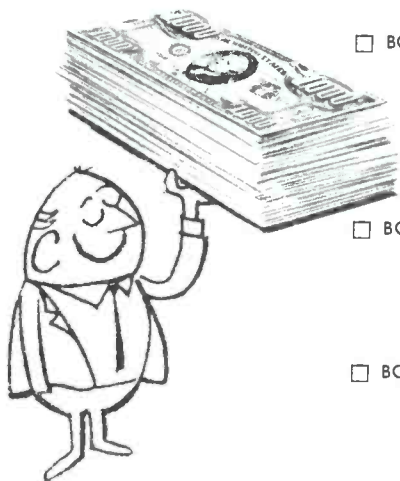

With a 1 year subscription or renewal you get your choice of any one of these items; with a two year subscription or renewal you get your choice of any THREE items, and a three year subscription earns you not only all FIVE items FREE, but we will bow towards your 10-20 once a week (on payday). Just check off the item or items you want, rip out this page and enclose it in the postage-paid envelope (in this issue) when you send in your subscription.

S9 Magazine • 14 Vanderventer Ave. • Port Washington, N.Y. 11050

Enter my subscription to S9 for  1 year at \$5.00

To begin with the \_\_\_\_\_ issue.

2 years at \$9.00

Name \_\_\_\_\_ Callsign \_\_\_\_\_

3 years at \$13.00

Address \_\_\_\_\_

NEW

City \_\_\_\_\_ State \_\_\_\_\_ Zip Code \_\_\_\_\_

RENEWAL



## ROSTER OF

# WEATHER BUREAU RADIO STATIONS



## FOR USE AT CB MONITORING STATIONS & SWL SHACKS

The following list is an unofficial roster of radio communications stations operated by the U.S. Weather Bureau. It has been compiled from several lists and for on-the-air monitoring reports. While every effort has been made to insure accuracy in this list, we do not guarantee that it is current and fully complete. If you have any corrections or additions to this list, please send them in to us.

These stations generally transmit weather forecasts to a central Weather Bureau office on a regular schedule. The stations on 2776 and 6977½ kc/s are hurricane stations running 250 watts, and these can usually be heard during severe weather disturbances in their areas. Most Weather Bureau stations will QSL correct reception reports of a self-addressed and stamped reply card is enclosed with your report.

Please remove this page and either place it on the wall of your shack or insert it in a three holed looseleaf notebook. Each month we will present similar listings of "utility" stations. To the best of our knowledge, listings such as these have never before appeared in a national publication.

CALL	LOCATION	FREQS. (kc/s)
KAE41	Albuquerque, N.M.	
KAE42	Milton, Mass.	30020
KAE46	Athens, Ga.	2776
KAE49	Naples, Fla.	
KAE50	Strevell, Idaho	3352 1/2
KAE51	Nantucket, Mass.	2776
KCB45	Mt. Washington, N.H.	30340
KCB46	Mt. Washington, N.H.	5925
KCB47	Albany, N.Y.	
KCB48	Mt. Washington, N.H.	34020
KCB49	Boise, Idaho	
KCB50	Burrwood, La.	
KCB53	Lake Charles, La.	
KCB83	Boston, Mass.	
KCB85	Blairsville, Pa.	
KCB89	Blanding, Utah	
KCB91	Blanding, Utah	
KEB83	Boston, Mass.	69 95
KEB86	Cape Hatteras, N.C.	6977 1/2
KEB87	Cape Hatteras, N.C.	2776
KEB88	Blanding, Utah	5925
KEB90	Blanding, Utah	3402 1/2
KEB91	Blanding, Utah	5925
KGD56	Burrwood, La.	
KGD57	New Orleans, La.	
KGD58	Annette Island, Alaska	

Continued

# ATTENTION! CB OPERATORS

SAVE ON CITIZENS  
RADIO EQUIPMENT

Buy Used And  
Discontinued Models  
From International  
Radio Exchange

Select that extra transceiver for  
mobile or base installation, or equip  
a new station. Our stock includes  
International types as well  
as other makes.

Write Today For A Complete  
List Of Equipment In Stock



**RADIO EXCHANGE**  
18 NORTH LEE, OKLA. CITY, OKLA.

A Division Of International Crystal Mfg.  
Co. Dealing In Used Citizens  
Radio Equipment



KGD64	Athens, Ga.	6977 1/2
KGD65	Show Low, Ariz.	3367 1/2
KGD68	New Orleans, La.	2776
KGD71	Missoula, Mont.	3367 1/2
KGD72	Washington, D.C.	6977 1/2
KGD74	Galveston, Tex.	
KGD79	Gambrill State Park, Md.	
KID63	Oberlin, La.	
KID73	Portland, Me.	30340
KID74	Portland, Me.	34020
KID75	Nantucket, Mass.	6977 1/2
KID76	Green River, Utah	
KID78	Pittsburgh, Pa.	
KID81	Platinum, Alaska	
KKE44	Winslow, Ariz.	3367 1/2
KKE79	Elko, Nev.	3402 1/2
KKE80	Mtn. Village, Alaska	
KKE82	Salmon, Idaho	3367 1/2
KKE83	Norfolk, Va.	
KKE84	Moab, Utah	
KKE85	Corpus Christi, Tex.	
KKE86	Port Alexander, Alaska	
KKE87	Tatoosh Island, Wash.	3357 1/2
KKE88	Astoria, Oreg.	3357 1/2
KME57	Portland, Ore.	
KME60	Washington, D.C. (Instr. Engineering)	
KOE20	Boise, Idaho	2852
KOE21	Grand Junction, Colo.	3402 1/2
KOE22	Roosevelt, Utah	
KOE26	New Orleans, La.	6977 1/2
KOE27	Anchorage, Alaska	
KOE28	Barrow, Alaska	
KOE29	Boston, Mass.	
KOE30	St. Paul Island, Alaska	
KQC48	Pocatello, Idaho	
KSC43	Grand Junction, Colo.	5925
KSC44	Kalispell, Mont.	
KSC46	Seattle, Wash.	
KUP54	Owyhee, Nev.	3402 1/2
KUP55	Albany, N. Y.	
KUP60	Burrwood, La.	
KUP62	West Yellowstone	
KUP64	Owyhee, Nev.	
KWO35	New York, N. Y.	162.55 mc/s
KWO39	Chicago, Ill.	162.55 mc/s
KWO41	Cape Henry, Va.	2182
KWO44	Mauna Loa, Hawaii	

#### Mobile Units

KC6209	Mobile Weather Station #1	
KC6210	Washington, D.C.	
KC6211	Hilo, Hawaii	
KC6216	Boise, Idaho	
KC6217	Pendleton, Ore.	
KC6218	Missoula, Mont.	
KC6219	Portland, Ore.	
KC6220	Seattle, Wash.	
KC6222	Mobile Weather Station #2	2776 6977 1/2
KC6223	Hilo, Hawaii	



# THE NO-HOOK SKY-HOOK

A "FREE" SHORTWAVE AND BROADCAST ANTENNA

by PETER DENDIN, 17W6366

Ever wish you could whip together a BIG receiving antenna without much effort? Here's a way to do it and also get yourself a whack at it by using your TV lead-in as a nice long wire antenna for your shortwave or broadcast receiver.

The circuit is constructed on a small square of phenolic or in a little plastic box—the parts are strictly junk box vintage and homebrew. For instance, the two capacitors,  $C_1$  and  $C_2$  can be anything from 20 to 50 mickey mikes (don't go over 50). These capacitors permit the TV signals to reach the idiot box, but the coil,  $L$ , forbids the radio signals from bouncing a long to the radio receiver antenna terminal ("A"), while permitting longer waves to pass through.

The coil is made from 40 turns of #22 wire on a 1/2" form. The center tap is a loop brought out at turn number 20. The coil is mounted on the phenolic square (or box, or whatever) by means of holes.

To prevent your radio from sending interference into the TV set, take a lead from the "ground" terminal (or chassis, if the radio receiver doesn't have a "G" terminal) and twist it along the antenna lead for a foot or so. The "G" terminal (or chassis) is

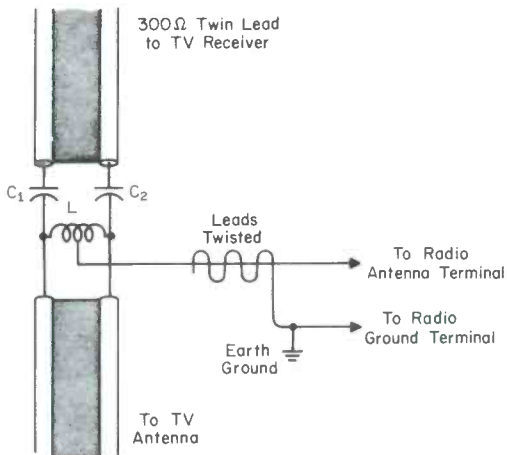

then grounded. Oh, don't fool around with this whole circuit with one of those chintzy little AC/DC sets—trying to ground the chassis could prove to be quite a hazard.

Anyway, all of the TV lead makes a really nifty antenna and can pull DX in for quite a distance on either shortwave or broadcast bands. This is *not* an antenna for transmitting CB signals, so don't bother trying it. It's fine for monitoring Channel 9 on a spare receiver though. The operation of the TV receiver should not be affected by this gadget.



♥♥ We Would LOVE To Show You Our QSL Card Samples

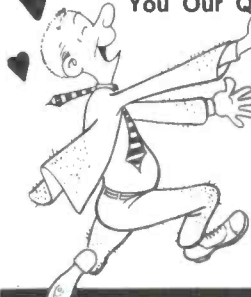

WE HAVE THE FINEST QUALITY, FULL-COLOR QSL CARDS. OUR ART AND PRINTING IS OF THE HIGHEST ORDER! ALL CARDS PRINTED ON GLOSSY STOCK.

FRANK B. MATHEWS  
Advertising Art  
1616 RURAL STREET  
ROCKFORD, ILLINOIS

SEND NOW FOR FREE SAMPLES

More people read more things in S9!

**S S B C O** TRUE SINGLE SIDEBAND for CB  
Go SSB on 27mc Citizens Band



TREMENDOUS BARGAIN!  
SSB-27 SIDEWINDER...\$164.95

write for  
MONEY BACK Trial Offer  
SSBCO-P.O. Box 101 Northtown  
Station, Chicago, Ill. 60645

**NEW YL PIN & TIE CLIP**  
Only \$1.50 each

the  
**Perfect Xmas Gift**

APOLLO ENGRAVING CO.  
P.O. BOX 81, BROOKLYN, N. Y. 11204



November 1965 • 27

# THE SUPREAMP

## A 1 TUBE HIGH GAIN, LOW NOISE RECEIVER BOOSTER

by ROD HUDSON, 11Q5362

Did you ever think that your CB rig could use a little more zip in the receiving department? Ever wish you could extend your receiving coverage? Do those weak signals wash out into the background noise?

Watch the SUPREAMP reach its arm right through the noise, get an iron fisted grip on the signal and drop it into your rig. It does all of this with only 1 tube and a minimum of components, adding a high gain, low noise RF amplifier stage to your receiver.

The tube in the SUPREAMP is a 6DK6, it has an amplification factor rating of over 35—that's compared with the rating of 20 through 24 for the tubes regularly used in the "front end" sections of many CB rigs. If "transconductance" ratings impress you, the 6DK6 is rated at micromhos; about 1800 higher than the "standard" front end CB tubes. So don't just sit there, let's get cracking and get it "on the air."

### CONSTRUCTION

I built this in a Bud #CU-3005-A Minibox, although any small chassis will make do rather well—keep the size about 3" x 4" x 5". Atop the box you will mount the following parts: the variable "peaking" capacitor, the "gain" pot, the tube socket and the 1 mh RF choke. Power for the SUPREAMP is lifted directly from the receiver section of your transceiver—it's 125 volts, and 6 volts for the heaters. The drain is relatively low and most rigs should be able to handle the extra load.

The coils will require a 10½ turn section of B&W 3015 Miniductor. Cut the wire (but not the insulation) at 3 turns and unwind ¼ turn from each end of the resultant 3 turn coil. This is L<sub>1</sub>. For L<sub>2</sub>, unwind half a turn from the remaining larger coil. This will leave you with 6½ turns for L<sub>2</sub>. Remember, do not cut the plastic insulating strips which are on the Miniductor as these will be left on to hold L<sub>1</sub> and L<sub>2</sub>.

Now you can heat up that trusty soldering gun. Solder a lead from the end of L<sub>2</sub> (the end closest to L<sub>1</sub>, that is) to the rotor terminal of the capacitor. The opposite end gets a lead running to the stator of the capacitor.

Next, mount a two terminal tie point connector on the left side of the chassis (just to the left of the capacitor/coil combination). Connect L<sub>1</sub> to this connector. This is the input

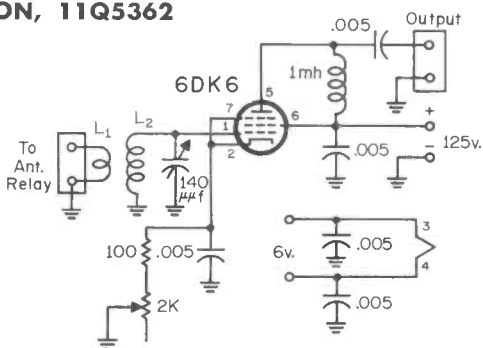

### PARTS LIST

- 1 140 ufd midget variable (Hammarlund HF-140 or equiv.)
- 5 .005 ufd, 600 volt ceramic discs
- L<sub>1, 2</sub> (see text)
- 1 1 mh choke (Miller 4559)
- 1 100 ohm, ½ watt resistor
- 1 2K ohm, 1 watt potentiometer
- 1 6DK6 tube
- Misc: chassis, terminal strips, tube socket, wire, coax, etc.

side of the SUPREAMP and will be attached to the "receiver antenna" side of the antenna relay by means of a short length of coaxial cable.

A similar piece of coaxial cable between the capacitor at the output and another two terminal tie point mounted on the opposite side of the chassis. A second short length of coax is run from this point to the "receiver input" point, which was formerly connected to the antenna relay. Your SUPREAMP is now placed in series with the wire which was formerly running between the antenna relay to the receiver section of your rig.

With your power connections made to the transceiver, the SUPREAMP will turn on and off with the CB rig. Wiring for the remaining components isn't critical—if you follow the schematic, you shouldn't have any problems.

When you have the SUPREAMP completed, turn your rig to Channel 9 and peak the variable capacitor on the background noise or on a signal for maximum showing on the S-meter. Once peaked, it should not have to be adjusted again, regardless of the channel used.

This should pull in those weak ones for you! See the difference on your S-meter.





*Here's a roof top antenna  
that actually does what  
others only claim to do!*

**NEW-TRONICS RT-27**

Many manufacturers of antennas claim performance figures far in excess of the physical and electrical capabilities of the particular model. Such statements and accompanying guarantees should be carefully scrutinized for accuracy.

The NEW-TRONICS RT-27, for installation on the roof of a vehicle, is as electrically and physically sound as modern engineering can make it.

Triple chrome plated mast with stainless steel spring is mounted on low profile one-piece base. Removable resonator with stainless steel tip rod for precise tuning on all channels. Height is 40 inches. Furnished with 15 feet of factory attached RG-58/U cable.

Compare the features, compare the price and you'll agree that the RT-27 surpasses any similar antenna available. See it at your distributors along with the PRO-27, the Base Station antenna that outperforms all others. Write for our complete CB catalog.



*"The Home of Originals"*

**NEW-TRONICS Corp.** / 3455 Vega Avenue  
Cleveland, Ohio 44113

**A HALF HOUR'S TIME  
AND YOU'VE GOT  
A MINIATURE  
VHF RECEIVER**

**THE  
POCKET  
RECEIVER**

**by THE GENERAL ELECTRIC COMPANY**  
ELECTRONIC COMPONENTS DIVISION  
OWENSBORO, KY.

The folks at General Electric kindly furnished us with this article which they have designed with some of their low cost semiconductors. It can easily be constructed by even the most inexperienced builder and will provide you with an interesting and useful piece of communications gear.

If you are interested in additional simple projects of a similar nature, we suggest that you ask your local GE dealer to secure for you a copy of GE's new book entitled "Electronic Components Hobby Manual," GE catalogue number ETR-3960. The book sells for \$1.50 and is 200 pages of both theory and construction details on numerous devices.

Of all services using radio communications, perhaps none are more interesting to the casual listener than the VHF communications of commercial airliners. These brief, often cryptic transmissions between aircraft and the ground contain vital information and add much pleasure on a visit to the airport or while riding aboard a plane as a passenger.

The bulk of these communications between air traffic control, approach control, ground control and aircraft occupy frequencies between 110 and 135 megacycles. While airborne, not only signals from your own aircraft are received, but many times you can hear scanning radars and as many as five have been heard while cruising at 30,000 feet.

This miniature, pocket-size receiver is passive (does not radiate a signal) and has sufficient sensitivity to receive signals at a distance of approximately 400-500 feet from the transmitter. It uses a broadband, untuned diode detector with two stages of amplification enclosed in a small plastic box. The signals are picked up on a three-turn loop antenna wound around the base of the box; broadly resonant at the desired frequency range. A 1N34AS diode detects the signals which are amplified by two transistorized

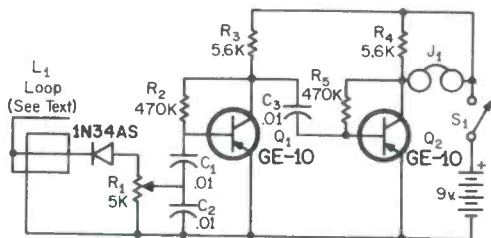

**PARTS LIST**

- C1, C2, C3**—0.01-mfd, 50-volt (General Electric MPC-451)
- CR1**—1N34AS diode
- J1**—Subminiature phone jack and plug
- L1**—2 turns insulated copper wire
- Q1, Q2**—GE-10 transistor
- R1**—5000-ohm subminiature potentiometer (Philmore PC-52 or equivalent)
- R2**—4700000-ohm, 1/2-watt resistor
- R3, R4**—5600-ohm, 1/2-watt resistor
- R5**—470000-ohm, 1/2-watt resistor
- S1**—SPST switch (Part of R1)
- Battery**—9 volts, snap-on type with 2-pole clip

stages (GE-10) and received on a crystal earphone. The audio level is controlled by a miniature volume control and knob mounted on the box cover. Inexpensive transistors greatly simplify the receiver circuit, while no compromise is made in performance.

All components, except the earphone, are mounted in a 2 7/8" x 2" x 1" plastic box.<sup>1</sup> The loop antenna consists of two turns of No. 24 AWG wire wound around the base of the box. This antenna length is not critical, the center top connects to the cathode of the 1N34AS diode. Holes through the box for the antenna

*Continued on page 70*

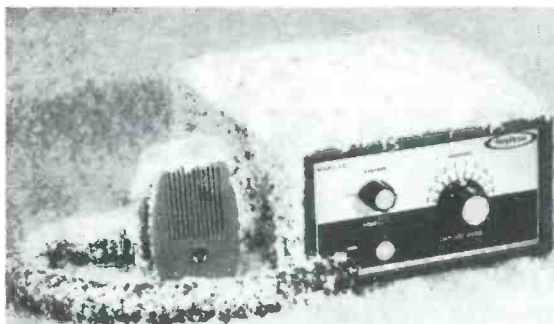

## Top sensitivity, even in the arctic...

One microvolt sensitivity, even at  $-10^{\circ}$  F. 0.4 microvolt sensitivity  $+10^{\circ}$  F. through  $+125^{\circ}$  F. . . . signal pulling capability that you can depend on, even in the arctic.

Completely solid state, the Amphenol "Six Hundred" has replaced the relay with high speed electronic switching to make it far more rugged than comparable equipment. Its dual conversion superhetrodyne receiver, with 4 stages of amplification provides outstanding selectivity.

Other significant advantages include a

powerful  $3\frac{1}{2}$  watt output, current drain that is actually less than a flashlight, and 10 crystal controlled channels.

The 600 is a 12 VDC compact, mobile unit at \$169.95; its companion model, the 625, in the same compact cabinet, includes a universal 120 VAC-12 VDC power supply at only \$20 additional. For more information including complete specifications, contact your local Amphenol communications distributor or write direct.

**DISTRIBUTOR DIVISION**

Amphenol Corporation

2875 S. 25th Ave., Broadview, Ill. 60155

**Amphenol**

### NEXT MONTH IN OUR SPECIAL CHRISTMAS ISSUE OF S9:

- **CALLBOOK OF 94 CARD SWAPPERS IN 33 DIFFERENT COUNTRIES!**
- **HOW TO SOUP-UP YOUR CB RIG BY CHANGING 1 TUBE!**
- **THE "VEE-BEE," AN INEXPENSIVE CB BEAM PROJECT!**
- **BUILD THE "007 SPECIAL," A MICRO-MINIATURE, ULTRA-COMPACT, MIDGET CB & COMMUNICATIONS RECEIVER FOR THE SPIES AMONG OUR READERS!**

**PLUS A FEW SURPRISES TO GIVE YOU ONE OF THE BEST ISSUES EVER! BETTER SUBSCRIBE NOW TO RESERVE YOUR COPY BECAUSE THIS ONE WON'T LAST ON THE NEWSSTANDS. CHECK PAGE 24 OF THIS ISSUE FOR SOME HOLIDAY GIFTS WE HAVE FOR NEW SUBSCRIBERS!**



### GOLDEN LINE C/B REPLACEMENT CRYSTALS



READILY AVAILABLE for these and 150 more MAKES and MODELS

Don't settle for replacement crystals "almost like" the ones you need for your transceiver. JK GOLDEN LINE CRYSTALS are tailor-made to virtually every set made. Most of them in stock. Buy the crystal—made by acknowledged precision crystal experts—from your JK dealer. Insist on the high-performance, 100% guaranteed JK crystal.

CTS KNIGHTS, INC.  
Sandwich, Illinois



# KYLE'S KORNER

## WRITE TO:

JIM KYLE, KEG3382  
% S9 MAGAZINE  
14 VANDERVENTER AVE.  
PT. WASHINGTON, N. Y. 11050

Well, it looks like I've went and did it again! Stirred up a small hornet's nest, that is. Last time I made an unguarded comment without thinking (and without making my meaning crystal clear) it took three years for people to quit being mad at me. Maybe this time it won't be so bad.

What brings all this on is a line in last June's column that "the FCC has ruled that QSL cards as such are not legal"; now everybody wants to know "What!" and at least one QSL printer has written for more data.

So here's the full and complete bit on it; maybe this will help erase a little of the mud I may have inadvertently tossed at a harmless side of our radio activities.

The basic ruling is this: The Citizens' Radio Service, like all other radio services except commercial broadcast and ham radio, is subject to the "Secrecy of Communications" provision of the Communications Act. Most of us know this as "Section 605."

Section 605 says (to paraphrase broadly) that no one may divulge anything he hears on the radio to anyone else, nor may he act upon anything he hears, to his own benefit.

I doubt that many of us would question this provision of the law; the extension of this provision to ban QSL cards goes as follows (simple when it's pointed out, but not exactly obvious): When you mail a card to someone, you are *divulging* to any postal employe who may see the card at least *one* thing you heard on the radio. This one thing is the fact that the other guy was on the air!

Let me make it perfectly clear that the ruling did not, in fact, ban the cards themselves. What it *did* ban was the mailing of these cards in the classic postcard manner. To be completely honest, the ruling itself went on to add that if the cards were mailed in sealed envelopes by registered mail to be delivered to the addressee only, no possible violation of Section 605 could occur and they wouldn't have a bit of official objection to the practice.

Of course, the original purpose of the QSL card, as I said before, was to *acknowledge* a contact (usually over a notable distance); the contacts themselves are now frowned upon by the new rules, but we're not discussing operat-

ing procedures at the moment. We're talking about QSL's and CBL's.

Quite early in the history of CB radio, the collecting of the cards (named CBL's almost immediately after the first one came off the press, by none other than our noted T.K.) became a hobby in itself. While in those original wide-open days, when the rules said nothing about working skip and Don Stoner could ask in a national publication "Who will be the first to work all states on C.B.?", the cards were serving the same purpose as the ham cards (confirmation of rare contacts), a large number of Cbers who had no inclinations at all to work skip did become interested in trying to collect a *card* from every state. No contact required; the card was the total object.

And from this came our present custom of card-swapping. We at S9 encourage the practice, as witness our card-swap listing feature. So far as I know, nobody at the FCC is officially (or otherwise) against it. Any more, dedicated swappers don't even waste time trying to collect the cards on the air. Instead, they put listings in the magazines and club papers, and the card swap activity at any jamboree is something fierce. So far as the harried officials at the commission appear to be concerned, the more time CB'ers spend swapping CBL cards, the less time they'll be on the air.

So that's where we stand today. The card itself is legal as can be, and my original statement—especially when taken out of context—was wrong. The *use* of the card for its original purpose has been held to be in violation of Section 605, *unless* you take great pains to make sure no one but the other licensee can possibly see the card until he gets it. Once he has it, he can publish it, since it's only *you* who are bound by 605 in this case (of course, it works both ways; for a two-way talk, each of you is bound by 605 insofar as what the *other* one said). And in case it is being used for its original confirmation purpose, you aren't worrying about being legal anyway.

I hope I didn't alarm too many of you, or (to use the words of one inquiry) "cast the stigma of illegality on such a harmless, wholesome and educational activity." Now let's get on with the regular questions, and see how long it is before



I insert pedal extremity into oral cavity and masticate well, again!

### THE POWERLESS PREAMP

Where does this circuit by Dick Turpin, KCF-2700, in the August issue get its power to operate? I tried it in a Courier and in an Olson Spotter 2, and it would not work in either one. How can I make it do what the article said?

—K.H., Beverly, W. Va.

*I only wish I could give you an answer to this one. I understand a lot of the rest of the gang are having trouble with this item too. Several years ago I put together a very similar circuit, actually by accident while clowning around. I had been playing with an ordinary one-transistor preamp and no matter what adjustments I made to it, it had about the same amount of gain. Finally, as a gag, I took out the battery and soldered a dead short across the battery terminals—and doggone if the thing didn't keep right on amplifying! I found it difficult to believe then, and I still do, but I had three other fellows check the thing out just to see if I had really blown my top, and it did work. The best any of us could ever figure out as to where it was getting power was that it was rectifying a part of the audio coming in, and using the DC voltage developed by this action as a power source for amplifying the rest of the audio. The major difference between my circuit and the one KCF-2700 had in August was that I used a large (as I remember, about 50 mfd) electrolytic capacitor in the output. If this change doesn't get some results, I would suggest adding a battery to the preamp. A single penlite cell ought to be enough to make it sit up and play real pretty.*

### AUDIO (FOR LISTENING ONLY)

I am building a stereo using two 12-inch speakers and two 3-inch speakers for tweeters in conjunction with a BSR record player which is being fed into a 20-watt single-end amplifier. My problem is that I have no bass or treble control worked out, and also do I need a crossover network? Can you help? Will you send me what you have?

—H.M.M., Lake Butler, Fla.

*Well, this is supposed to be a CB magazine and column—but if nobody else minds branching off now and then, I dern sure don't mind either. Fact of the matter is that my major work these days (aside from the column) is deeply involved with digital computers, not with communications at all! And as I write this I'm listening to my new transistor hi-fi (mono) completed last night and now undergoing life tests before I put it in the cabinet. You don't say, but I assume your 20-watt amplifier is using tubes rather than transistors. For bass and treble control you have basically two choices; you can use a "losser" circuit, or a "feedback" control system. My preference, especially for beginners' use, is the losser. It's much easier to get working right. There's a schematic around here someplace. This circuit works at a nominal 1-volt signal level. If you're using a magnetic cartridge, the preamp should come before this circuit, and the main amp after. Purists might argue that you need a crossover, but I wouldn't invest any cash in one until trying the system barefooted. Just wire the 3-inch in parallel with the 12-inch. Normally the 3-incher won't accept power at the low frequencies, nor will the woofer at the high end. If it doesn't sound right this way, then add the crossover.*

### TUNING A CRYSTAL SET

I own a Polycomm II with crystal receive. I seem to recall an article in some magazine telling how to make it tunable. I would appreciate it very much if you would let me know how to accomplish this.

—R.R., Wantagh, N. Y.

*Polytronics themselves make an accessory for the "N" and IIG transceivers which they call the Poly-Tuner, which does exactly this. It's a single-tube tunable oscillator which takes its power from the transceiver from the accessory plug on the back, and tunes the range from 16.4825 to 16.6125 Mc. Its output plugs into the rig's crystal (receive rock) socket. A schematic of this appears somewhere around here, but I don't really recommend that you try to build one. You'll note that the location of the tap on the coil is not specified, nor is the value of the fixed capacitor across the tuning capaci-*

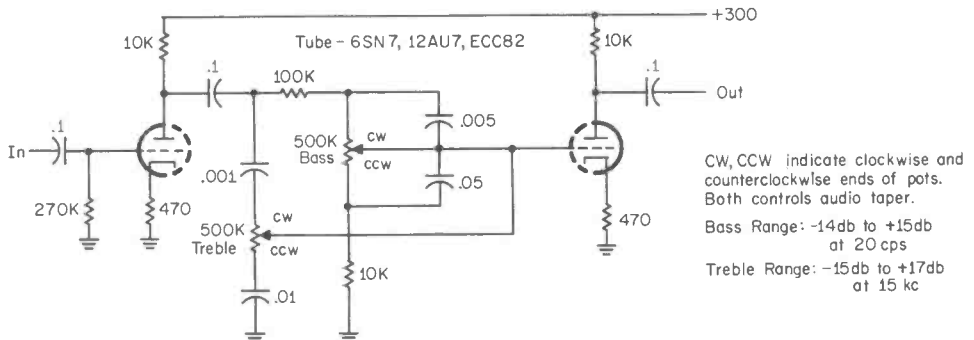

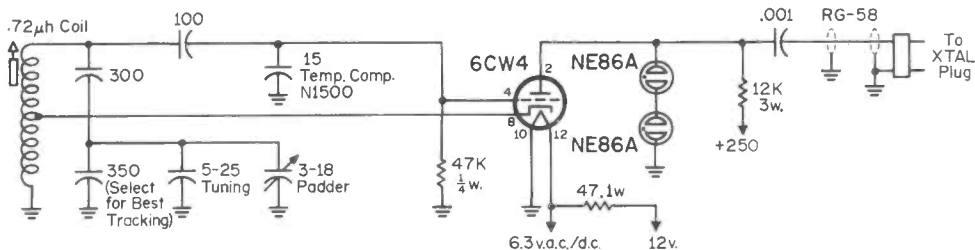

Poly-Tuner Schematic (S-Meter Omitted)

tor specified precisely. Both would have to be determined by trial and error, so you'll be much better off to simply buy one of the units if you can locate one.

### A PAIR FOR OPENERS

I've been reading your "Kyle's Korner" and I have but two simple questions for you: How

#### WE NEED CB DEALERS!!

AS distributors handling all Major brands of CB equipment, antennas, and accessories we can offer local dealerships to aggressive CB dealers and installers. Write at once for information and your costs on the brands you prefer to handle. Dept. 624

**KNOX ELECTRONIC SUPPLY, INC.**

67 N. Cherry St., Galesburg, Illinois.



## What's new PUSSYCATS?

Go get 'em tiger with the new Super Star Burst Model SB 100 base station antenna. At last, throw a BIG 9 watts (ERP) of dynamic CB signal onto the band. Designed especially for CB'ers located in dead spots, imagine what it will do if you have a good 10-20! Almost no SWR, all you get is SIGNAL—devastating and withering. We challenge any other antenna, regardless of price, regardless of type, to an on-the-air test of talkpower and coverage. So—GRRRRR—go get 'em tiger with the Super Star Burst Model SB 100! This is NOT an experimental antenna, it has been tried, tested, and proven to be THE ULTIMATE CB antenna. Still doubtful? Read what S9 had to say about it on page 44 of the October issue.

#### ASTRO ANTENNA CORP. OF AMERICA

2 Rock Spring Road, West Orange, N. J., Dept. S

ENCLOSED IS MY  CHECK  MONEY ORDER  
 \$ 5.00 DEPOSIT, BAL. C.O.D.  
 \$32.50

FOR A SUPER-STAR BURST MODEL SB-100

NAME \_\_\_\_\_  
 ADDRESS \_\_\_\_\_  
 CITY & STATE \_\_\_\_\_

many S-units is a db (decibel) equal to? What is the general public reaction to the new Lafayette HB-400 transceiver? Thanks a lot.

—T.P., Indian Orchard, Mass.

The fast answer to the first one is "It all depends on the S-meter"—but I assume you want a slightly more serious reply. By general convention, one S-unit is believed to be equal to 6 db, which in turn means twice as many microvolts are coming in. The trouble is that the S-unit system was originally a measurement "by ear"; S1 was what you were to report for a signal whose presence was "distinguishable with difficulty and often missed," while S9 was the report for "an extremely strong signal." This was many years ago, before S-meters even existed. When the meters came into use, designers attempted to make them read the same numbers people had been using, at least at first. Through the years, the meanings kept changing (in an upward direction), and today when you hear an S-report it makes you wonder. Seems as if an S9 signal today is the kind we used to report S1, and everything is in "db over 9." This situation is why my fast answer is "It all depends on the S-meter." Now to your second query (and I'll say before I begin to reply that the people at Lafayette have not influenced this answer in any way), it appears from here that this rig has in the relatively short time it's been around gained a reputation for outstanding audio. I put one through its paces the first month they were around, and received a "heard clearly" report by the grapevine from a station some 50 miles away. Range of this sort is unheard of for a legal installation in my part of the country. I have heard occasional gripes about HB-400's failing to work properly when unpacked, but no more than I have heard on any other make of unit, and I attribute these gripes (for all makes) to the general attitude of most equipment users that "When all else fails, read the instruction book." Most problems are already solved, if one reads the instructions carefully.

#### WILL CROSS-POLARIZATION WORK?

I am confused about antennas and their polarization. I've heard that vertically polarized antennas will not be able to receive a transmission from a horizontally polarized antenna and

*Continued*

Live Better Electronically With

# LAFAYETTE RADIO ELECTRONICS



# FREE!

## LAFAYETTE 1966 Catalog 660

Now **BETTER THAN EVER**

Shop At The  
"World's Hi-Fi &  
Electronics Center"  
For Widest Selection,  
Low Prices

Stereo Hi-Fi • Citizens  
Band • Ham Gear •  
Tape Recorders • Test  
Equipment • TV and  
Radio Tubes and Parts •  
Cameras • Auto Acces-  
sories • Musical Instru-  
ments • Tools • Books

SEE LAFAYETTE'S NEW CB UNITS  
LARGEST SELECTION IN THE U.S.A.!

25 CHANNEL DELUXE 5 WATT  
SOLID STATE CB TRANSCEIVER  
MODEL HB-600



12 CHANNEL CRYSTAL CONTROL  
5 WATT SOLID STATE MOBILE  
CB TRANSCEIVER MODEL HB-555



12 CHANNEL CRYSTAL CONTROL  
5 WATT TRANSISTORIZED CB  
TRANSCEIVER MODEL HE-20d



LAFAYETTE "COMSTAT 9"™ KIT  
5 WATT 9 CHANNEL CRYSTAL  
CONTROL CB TRANSCEIVER



Featuring Everything  
in Electronics for  
**512**  
**Pages** • HOME  
• INDUSTRY  
• LABORATORY  
from the "World's Hi-Fi &  
Electronics Center"

Mail the Coupon Today for Your  
FREE 1966 Lafayette Catalog 660

Use Lafayette's Easy-Pay Budget Plan  
No Money Down... Up to 24 Months to Pay  
Satisfaction Guaranteed or Money Refunded

#### STORE LOCATIONS

NEW YORK  
Brooklyn  
Syosset  
Manhattan  
Jamaica  
Scarsdale  
Bronx

NEW JERSEY  
Newark  
Paramus  
Plainfield

MASSACHUSETTS  
Boston  
Natick  
MARYLAND  
Mt. Rainier  
(Wash. D. C. Area)

LAFAYETTE Radio ELECTRONICS  
S9K5, P.O. Box 10

Syosset, L.I., N.Y. 11791

Send me the Free 1966 Lafayette Catalog 660

Name .....

Address .....

City .....

State ..... Zip .....

(Please Give Your Zip Code No.)

vice versa. It doesn't seem to make any difference on a BCB radio. Could you explain this for me and all the other CB'ers?

—J.K., East Peoria, Illinois

You're not alone in your confusion on this point. If anyone reads the theory books, alone, and doesn't bother to check it out in practice, he will insist that it is not possible for a vertical transmission to be received on a horizontal antenna. But, as you point out, it doesn't seem to make any difference on a BCB radio. In fact, it makes very little difference anywhere in the spectrum below around 30 Mc, and doesn't get to be a real pressing problem until you're well into UHF. If it did, rabbit ears could never receive TV, since our TV transmissions are horizontal and rabbit ears come closer to being vertical than anything else. What happens is this: At the lower frequencies, where wavelengths are longer, the polarization gets twisted around very rapidly after leaving the transmitter. No matter what you transmit, by the time it reaches the receiver it's a mixture of vertical, horizontal, right circular, left circular, and a little of everything else as well. The lower the frequency, the more scrambled the polarization gets, so on BCB reception you'll never know the difference. By the time the frequency gets up to the 11-meter band, you can tell some difference, but in practice it's seldom more than about 6 db for us (roughly, one S-unit). In the TV region, the difference is more pronounced, and when you get into UHF, then you do in fact have situations in which you can put two different signals on the same frequency into the same space and still keep them separate by transmitting one vertical and the other horizontal. Does this just add to the confusion, or does it help a little?

### PORTABLE OPERATION LEGAL?

If you were licensed say in Rhode Island and you came down to Florida for a vacation and used your call letters, would that be a breach of regs? Would you have to change your call numbers to the Florida area, or would the ones you have be OK?

—R.E.M., U.S.S. Lexington, Pensacola, Fla.

## U.S. GOVERNMENT OFFICIALLY LICENSED RADIO COMMUNICATIONS UNIT

"OFFICIAL" card for your mobile unit's window—very impressive and printed on heavy quality card stock. White stencil letters on black background. With each order a FREE realistic "U.N.C.L.E." ID card in 2 colors — and an extra surprise bonus sticker! The whole bit for 50c, three sets for \$1.

HARAL ASSOCIATES,  
Dept. CB, 1133 Broadway, New York, N.Y. 10010

So long as you were in Florida just on a vacation, and so far as I have been able to find out, you would simply use your original call letters even though they appeared to identify you as a Rhode Island station. However, you would also need to identify your location verbally, such as "This is KEG3382 on vacation in Pensacola, Florida," so that the FCC monitors would know your location. Under no circumstances would you, yourself, make any change in the assigned call; if your move to Florida were permanent rather than merely a visit, you would have to send for a new license with the new address on it. But so long as the FCC is able to reach you readily by sending mail to the address to which your license was issued, which would be the case if you were merely on a visit, you would have no need to change the records.

### MORE CALL-SIGN QUESTIONS

Would you please tell me if there is any correct procedure for using the CB callsigns, according to the FCC? Some persons have told me that you are supposed to say three-three-eight-two, rather than thirty-three, eighty-two. Which do you think is correct?

—W.D.B., Spencerport, N. Y.

Well, for myself I always identify as "thirty-three-eightytwo", but I hear a lot of people doing it the other way too. So far as I know there is no prescribed manner of doing it, except that the identification must be in the English language and must include the entire assigned callsign (The K, the E, and the G, as well as the numbers, in my case). This is a definite difference between CB regulations and ham regulations; the hams have a strictly specified manner for identifying their stations, but our regulations are rather loose. In fact, they're almost identical to those of most of the commercial radio services, which assume that the operator is a serious person and not a muddle-headed experimenter who must be led by the hand through the proper method of identification. Personally, I take it as a compliment to the skill of our operators! (Before all the hams who are also CBers gripe at me for a possible slur, let me add that I hold a ham ticket too—and speaking for the moment as a ham I consider the extremely strict identification procedures prescribed there as a slur on the intelligence of all hams; blame the rules, boys, not me!)

Which brings us smack up against the end of the allotted space for another month, with a whole batch of unanswered questions still in the box. Right up on top is one entire group asking for more poop on beam antennas, with especial detail requested on the actual construction material and technique. Unless something goes wrong, I'll lead off with that discussion next time. Until then, I'll be looking forward to hearing *your* question; send it to me c/o the address at the top of the column. And I'll CBing you . . .

**S9**



Is Hallicrafters' new solid-state,  
23-channel (they all work),  
S-metered, loud-hailer-  
circuited, model CB-14 . . .  
*the ultimate CB transceiver?*



See your dealer or  
send for complete specifications,  
and judge for yourself.  
We're prejudiced.



***hallicrafters***

5th & Kostner Avenues, Chicago, Ill. 60624

*"Quality through Craftsmanship"*

Export: International Div.  
Canada: Gould Sales Co., Montreal, P.Q.

**Congratulate  
yourself for  
holding out!**

**Now from  
Courier!  
The world's  
smallest,  
most sensitive,  
most powerful  
transistor  
CB line!**



## 6 Channels \*COURIER TR-6

6" W x 6 $\frac{3}{4}$ " D x 1 $\frac{7}{8}$ " H

■ SILICON TRANSISTORS. Illuminated channel selector. Auxiliary speaker jack. 4" oval speaker. Transmit indicator. External channel socket. Top or bottom speaker mount. Channel 9 crystals.

**\$129**



## 12 Channels \*COURIER TR-12

5 $\frac{1}{16}$ " W x 5 $\frac{5}{16}$ " D x 1 $\frac{5}{8}$ " H

■ SILICON TRANSISTORS. Collins filter. Illuminated S-RF meter. Illuminated channel selector. PA System. Auxiliary speaker jack. Modulation indicator. Channel 9 crystals.

**\$169**



## 23 Channels \*COURIER TR-23

6" W x 7 $\frac{1}{2}$ " D x 2 $\frac{1}{2}$ " H

■ SILICON TRANSISTORS. All crystals supplied for 23 channels. Illuminated S-RF meter. Illuminated channel selector. PA System. Auxiliary speaker jack. Single knob tuning. Modulation indicator.

(Delivery, Dec. 15, 1965). **\$209**

\*All units include: Microphone, Mounting Brackets, DC Cord, Chrome Cabinet. PLUS exclusive Courier circuit protection against mismatched antenna, incorrect polarity, and overload.

AC POWER SUPPLY for above units \$29.95

**FOR THE ULTIMATE  
IN BASE STATION  
OPERATION!**

**RANGE EXTENDER  
COURIER-23**

■ 23 Channels ■ Dual Conversion  
■ Transistor Power Supply ■ Includes  
all crystals, mounting brackets,  
power cords and noise-cancelling  
microphone. **STILL \$189.50**

World famous manufacturers of quality CB and BB equipment, including Courier 23, Courier 1M, Courier 30 B, Fleet Courier, Port-A-Lab, Transistorized Power Supply, Linear Amplifier.

 **electronics communications inc.**

56 Hamilton Ave.  
White Plains, N. Y.

Yes! I'd like to know all about Courier's new 6-12-23 Channel SILICON-TRANSISTOR CB line!

Name \_\_\_\_\_

Address \_\_\_\_\_

City \_\_\_\_\_ County \_\_\_\_\_ State \_\_\_\_\_



# M

FOR COMMUNICATION ANTENNAS.

# Mosley

ELECTRONICS INC.

## CB Base Station &

**GUARANTEED To Equal Or  
Out-Perform Other CB Antennas  
On The Market Today**

Here's the famous base station antenna with incomparable 'Talk Potential'... the Devant-1 vertical ground plane, featuring the revolutionary Mosley Induct-O-Match accomplished through loops of 1/8" aluminum rods. This light-weight omni-directional antenna is ideal for temporary and permanent base installations.

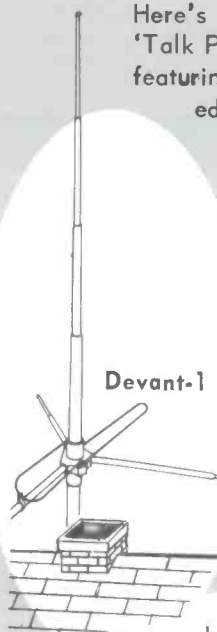

Devant-1

Another Mosley winner is the Devant Special vertical Ground Plane antenna featuring a Top-Hat of 10-inch radials, an extremely low angle radiation; antenna is guaranteed for three years. This antenna radiating equally well in all directions, incorporates the Mosley reputation of quality through superior engineering construction.

Point your signal where you need it... from home to mobile... from base station to base station with a NEW Mosley A-411-S.

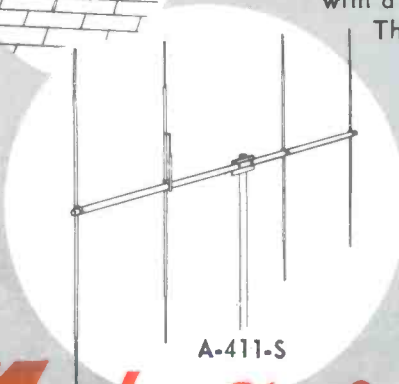

A-411-S

This Power-Packed beam constructed of strong, durable aluminum features a 'QRM - Punching' Gain of 8.7 db. over 1/2 wave dipole or 11.2 db. compared to isotropic source.

**FREE** 1966 CB Catalog  
available upon request  
Send for your copy Today!

# Mosley Electronics, Inc.

4610 NORTH LINDBERGH BLVD.  
BRIDGETON, MISSOURI, 63044



- **CB'ers, Demand The 'TALK POTENTIAL' You Deserve . . .**
- **Select A Rugged Mosley CB Antenna**
- **With Amazing 10-2 Performance**

## Mobile Antennas

NEW...ALL NEW...is the Demon DA-27..... a 'Devil of a Performer'! This antenna with overall length of 17" is constructed of durable, flexible stainless steel. Tuning is possible through a simple whip adjustment allowing antenna peaking at desired frequencies. Loading is accomplished through coil in center of whip.

Another NEW mobile antenna is the Deputy-DP-27...a Badge of Dependability with overall length of 43¾". Whip is constructed of strong, flexible stainless steel, incorporating a special whip adjustment allowing antenna peaking at desired frequencies. Loading is accomplished within base section.

Expertly styled, the Devant-2 mobile companion for the Famous base station Devant-1 antenna features the ultimate in trim, slim-line construction. Whip incorporates Top Grade stainless steel requiring no tuning for efficient mobile performance.

Select a Mosley Mobile or Base station antenna for your own specific CB needs. For more information on the Wide Line of Mosley Top Quality antennas Write . . .

# MOSLEY

**ELECTRONICS INC.,**

4610 N. LINDBERGH BLVD.,  
BRIDGETON, MISSOURI, 63044.

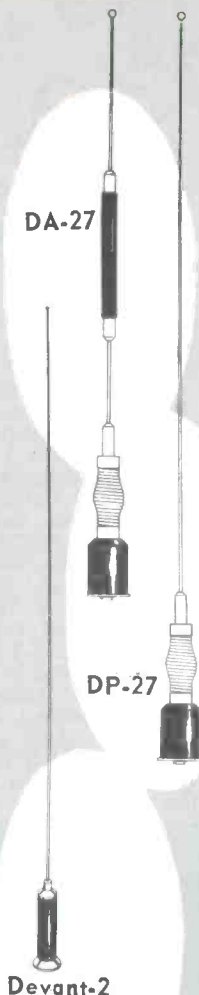
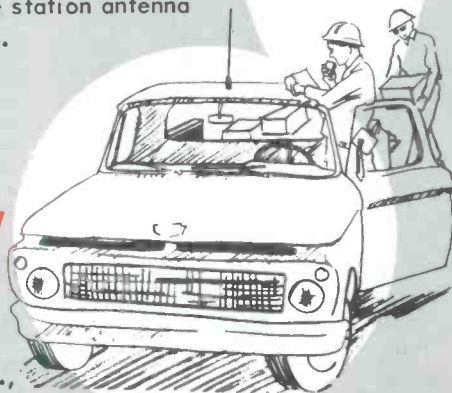



# ON THE COUNTERS

Webster Manufacturing, 317 Roebing Rd., South San Francisco, Calif. passes along word of their new Webster A-85 CB/AM combination CB and broadcast band antenna for mobile use. It employs an encapsulated top-loading coil to achieve quarter-wave resonance with an SWR of 1.1 to 1. A signal divider, provided with the antenna, prevents the CB signals from leaking through into the broadcast receiver (you can use both rigs at the same time). Price is \$24.50, list.

Getting right on the ball for Christmas is Lafayette Radio, Dept. S9-K5, 111 Jericho Turnpike, Syosset, L. I. 11791. They have a unit called the Model GT-3 ARMY COMMANDER CB WALKIE-TALKIE. Not "just a toy," the GT-3 is styled to look similar to the famous BC-611 walkie-talkie of World War II fame. It has 3 transistors, a separate earpiece and mike. You get about a quarter of a mile out of one. Price is \$11.50 each, or \$10.95 each for two or more. And say, did you get your copy of the new Lafayette catalogue? No? It's

free and they'll be happy to rush you one if you send a post card or QSL to the above address.



Master Mobile Mounts has introduced to the CB world the "New Dual Select-A-Battery" control system, designed to provide a complete two battery system that can be controlled from the driver's seat. It operates independently of the ignition switch, and will function in conjunction with either an alternator or generator system. Suggested retail price is \$28.95. Address is 4125 W. Jefferson Blvd., West Los Angeles, Calif. 90016.

Ron Nixon, P.O. Box 145, Yale, Mich. 48097, has come up with a nifty idea. He takes any QSL card, reduces, and prints it as a photographic postage stamp on perforated stock. Price is \$2 for a sheet of 50 "Mini-QSL's." He can also do a similar job on your CB license (he has dubbed these "Mini-Licenses"). Special low rates are in effect for clubs and quantity users. We have seen some of Ron's work and can recommend it highly. Good idea for Christmas gifts—take your buddy's QSL card and order him a sheet of Mini-QSL's.

Mosley Electronics, 4610 N. Lindbergh Blvd., Bridgeton, Mo. 63044 has some new CB antennas for you. First off we have the "Demon DA-27" mobile sky hook with an over-all length of only 17 inches. Construction is a flexible, durable, stainless steel whip, center loaded with an adjustment for peaking at any channel. SWR is 1.5 to 1 or better. The Demon is supplied with 24 feet of cable.

Next we have Mosley's "Dispatcher" base station antenna for business band use in the band of 27 through 50 mc/s. It's an economical 5/8 wave vertical which stands 20 feet tall for

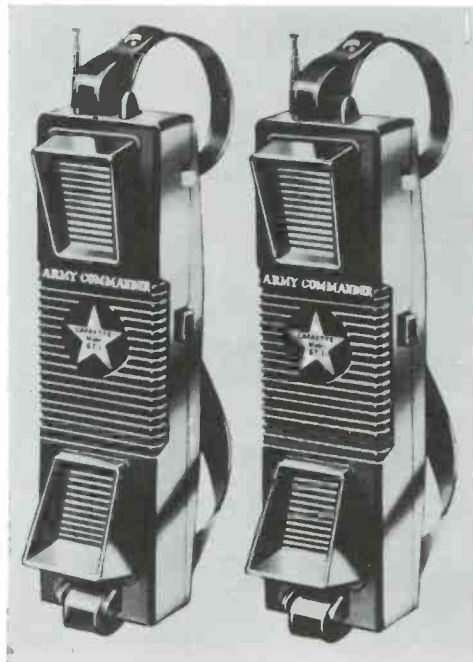



27 mc/s use. Gain is claimed to be 3.4 DB over a quarter-wave GP. Will handle up to 1000 watts.

Mosley's other new addition is the "Deputy DP-27" mobile whip, a 44-inch beauty designed for roof top mounting. SWR is said to be 1.5 to 1 or better and they send along 24 feet of transmission line with the antenna.

Free brochures are available on all of the above.



The Sentry is a new CB rig from Pearce-Simpson, Inc., Box 800, Biscayne Annex, Miami, Fla. 33152 (note new 10-20). The Sentry was designed to compete in the new H.E.L.P. plan and offers the motorist both transistors and hybrid tubes in a 6 channel unit. Features include a superhet receiver, pre-set ANL, adjustable squelch. Weighing in at 7 pounds, the rig sells for—well we bet you guessed wrong—It goes for \$99.50! Want more details? Write to the manufacturer.

The "CB Distance Gainer" is a new product from Carroll Electronics, 3175 Barron Ave., Memphis, Tenn. Manufacturer says that this unit will increase the sensitivity of your CB receiver 80 times by means of a Nuvistor. The gain of the preselector can be raised from approximately 4 DB to 18 DB or more, depending on conditions. It is small enough to fit inside any CB rig and can be installed in about 30 minutes. Price is \$15, wired and fully tested (it's smaller than a penny match box).

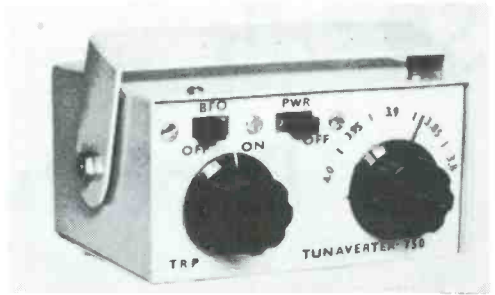

Ever hear of a "Tunaverter?" It's a transistorized converter for home and mobile use and different models are available for the marine band, for the SW band from 14 to 18 mc/s, and for the 160, 80, 75, 40, 20, and 15 meter ham bands. Prices are \$19.95 (wired and tested) or, if you want a built-in BFO for CW reception, \$24.95. The manufacturer also has a Model TRP-50B all transistor modulator and power supply combo unit for ham transmitters up to 70 watts, and receivers using 12 volt power. Output is 500 volts 120 mils (100% modulated), 250 volts 100 mils, and 35 watts of audio (lo Z or carbon mikes). Price is \$98.50. Details on these and other products are available from Herbert Salch & Co., Woodshoro, Texas, 78393—and don't forget to tell them that you saw it in S9. By the way, you can order directly from the Salch people.

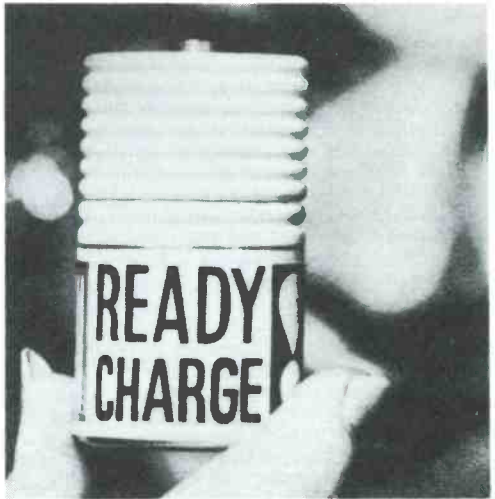

A new type of rechargeable power supply battery, designed as a lifetime replacement for the standard "D" cell has been brought out by the En-Power Company, P.O. Box 1526, San Mateo, Calif. Called "Ready-Charge," it's the same size as a "D" cell, it has a capacity of about a full ampere hour at the 10 hour rate. In lab tests, the batteries have been discharged and recharged thousands of times. Overnight connection to 110 volts restores the unit to a full charge. Suggested retail price is \$4.95 per battery.

**S9**

# S9 Lab

## Reports

### TESTING THE LAFAYETTE HB-600

At the *least*, the HB-600 is a *major* breakthrough in CB communications. While there have been continuous series of improvements to CB transceivers they have been in the nature of improving what already existed, or as compensation for an existing deficiency—such as “spotting” on a continuously tuned receiver. The HB-600, however, takes a giant step forward with an RF noise blanker, a device which virtually eliminates all trace of the pops, clicks, buzzes and hash which often makes mobile operations an intolerable grind.

To start, the HB-600 is all solid-state, using silicon transistors which are less prone to heat caused changes in their characteristics. The receiver section utilizes a mechanical filter which results in almost interference free reception. In practical tests, interference from adjacent channel stations was almost non-existent; only stations located within a one or two block area or “spill” from overmodulation caused a trace of adjacent channel interference.

As with the transmitter, 25 switch selected channels are provided; the regular 23 plus two positions—labeled A and B—for use when the HELP channels are authorized. If desired, the A and B channels can be used for “Business Band.” While the Business Band *requires a special license* it offers the advantage of almost QRM-free conditions, and the user could therefore utilize a single modest priced transceiver for both Business Band and CB operations.

The exact function of the spare channels is user determined, just plug-in the appropriate crystals. For example, position A could be assigned to HELP with B used for the Business Band; thus, in a single transceiver all communications facilities within the 11 meter band can be utilized with a single purchase.

The receiver's sensitivity is  $\frac{1}{2}$  microvolt, with very high reserve audio gain and excellent audio quality. The squelch is also excellent as it does not go in sharply (either all on or all out). Rather, a broad adjustment of the squelch control “fades” the squelch in, allowing the user to keep a small bit of background noise (some operators like a bit of noise so they know the squelch isn't set too “hard,” unable to release on weak signals).

It is in noise limiting where the HB-600 really sparkles. First, the HB-600 has a standard noise limiter which by itself is notably good; but there a user selected option which combines an RF noise blanker with the limiter, and noise becomes almost non-existent.

The noise blanker is a separate RF amplifier



which samples the 25 mc/s noise coming in the antenna lead. Since the noise at 25 mc/s is essentially the same as the noise at 27 mc/s the output of the 25 mc/s amplifier is representative of the 27 mc/s noise going through the receiver. The 25 mc/s noise pulses are rectified and amplified so what comes out of the 25 mc/s amplifier is a DC pulse representing the noise pulse. This noise pulse is then applied to the receiver's first mixer, which is also a DC controlled gate. Whenever the DC pulse representing the noise is applied to the gate it is cut off, and no signal feeds through to the IF amplifier. Therefore, whenever a noise pulse enters the receiver the gate is closed and a “hole” is “punched” in the received signal. The result, *absolutely no noise*. All that's left under severe noise conditions is a slight steady hiss which is not annoying (similar to “tape hiss” on a budget tape recorder).

In practical mobile tests, the HB-600 was able to receive weak signals with almost 100% intelligibility while other transceivers were effectively blocked by ignition noise.

While Lafayette only claims the silencer is effective against impulse noise we found it to be effective against other types of noise, such as fluorescent lights, sewing machines and oil burners.

The transmitter also offers a top quality extra feature—*range boost*. The user selected range boost is a combination clipper and compressor delivering about a 6 db increase in talk power with an average voice. Modulation is very sharply limited to 100%. Over-all modulation quality is very good—sharp and crisp with lots of talk power.

The transmitter delivers a little over 2 $\frac{3}{4}$  watts output to a 50 ohm load. We found the factory tuning was on-the-button and required no changes when an antenna was connected. The S-meter doubles as a power output meter calibrated directly in watts. On our model the output meter was somewhat generous, indicating about 3 $\frac{1}{2}$  watts output when the actual output was slightly over 2 $\frac{3}{4}$  watts.

The power supply is designed for 110 VAC or 12 VDC. The supply's primary is “floating”—no common ground—and the HB-600 can be used in vehicles with either positive or negative battery grounding. Extra features include a multi-position mobile mounting bracket, a phone jack, PA operation and a 2nd harmonic TVI filter.

While just the noise silencer alone justifies the \$219.95 price tag, the HB-600's all-around outstanding performance justifies its being rated a “best buy.”

### THE WATERS CLIPREAMP

A CB accessory that has been gaining popularity is the Waters Model 372 Clipream, a

When experience counts, it's S9 every time!



solid-state (transistorized) device that is used as a speech amplifier and a clipper to legally increase the average voice-modulated power of the transmitter in order to obtain more effective voice communications. Through proper design, the Clipreamp provides this higher average power with negligible distortion and it shapes up the speech characteristics for maximum intelligibility.

It is a self-contained unit, powered by an internal battery. All you have to do to install it is to connect it between the microphone and the transmitter.

### HOW IT WORKS

The nature of speech is such that the *average* volume (amplitude, or level) is quite a bit less than the *peak* amplitudes that intermittently occur at very short intervals during a train of voice sounds. The *peak* amplitudes during voice transmissions are what limit the maximum permissible microphone amplification that can be used with a transmitter without causing overmodulation, distortion or interfering splatter. Due to these restrictions and the speech characteristics, it then follows that the *average* voice power put out by the transmitter is relatively low.

In addition, the large peak amplitudes usually are produced by the lower-pitched (low-frequency) voice sounds which contribute little to intelligibility. On the other hand, the higher-pitched sounds are those needed to make speech understood, but unfortunately they have smaller amplitudes compared to the less needed low-frequency voice sounds, so due to the *peak* amplitude restrictions just mentioned, they are transmitted at relatively lower power levels.

A clipper increases the *average* power in relation to the *peak* power by limiting the amplitude of the strong voice components without cutting down the weaker ones. This allows you to use more speech amplification and thereby increase the *average* transmitted voice power without causing overmodulation. At the same time, the intelligence-bearing sounds also are relatively increased and you have more effective voice communications.

An inherent difficulty with clipping is that distortion can be created with it, particularly if excessive clipping is used; however, the Waters Clipreamp employs special filtering before and after clipping which, together with the use of proper operating levels, minimizes the possibility of noticeable distortion. The filtering also favors the most useful voice frequencies to further provide the best intelligibility.

### INSTALLATION AND OPERATION

The Clipreamp is a neat looking unit that is housed in a tilt-up metal case 2 $\frac{3}{8}$ " H. x 3 $\frac{1}{8}$ " W. x 3 $\frac{3}{4}$ " L. A switch on the panel turns on the battery and places the Clipreamp in operation. When the switch is off, the Clipreamp is cut out of the mic circuit and the microphone is connected directly through to the transmitter. There also is a *clipping-level* con-



## NEW PACE II 12-channel mobile CB transceiver

with superior talk power plus  
silicon transistor reliability  
at only \$169.00

Advanced circuit design, all silicon transistors, lifetime guaranteed glass-fiber circuit boards, and more exclusive features, combine to give you more value than any other 2-way radio on the market.

**3.5 watt output** (at 100% modulation) — the most talk power you can get from a 5-watt transmitter.

**Best mobile noise limiting** with exclusive noise limiter extender, for standard or deep noise clipping.

**Exclusive squelch sensitivity adjustment** on rear panel (in addition to standard squelch control).

**Ruggedly constructed** for top performance in temperatures of  $-30^{\circ}\text{F}$  to  $+185^{\circ}\text{F}$  and in any mobile installation.

Size: 7" x 2 $\frac{3}{8}$ " x 8 $\frac{3}{8}$ ". Weight: 4.2 lbs. Power source: 12VDC, positive or negative, or AC Power Pack, accessory. Quick disconnect "Latch Rak" for ease of mounting.

Write for Bulletin Pace II, and the name of your nearest Pace dealer.

FCC station license required. All use must conform to part 95, FCC regulations. Hobby-type communications or any aimless small talk prohibited.



**PACE**  
COMMUNICATIONS CORP.

24049 Frampton Ave., Harbor City, California 90710  
Telephone: (213) 325-8444

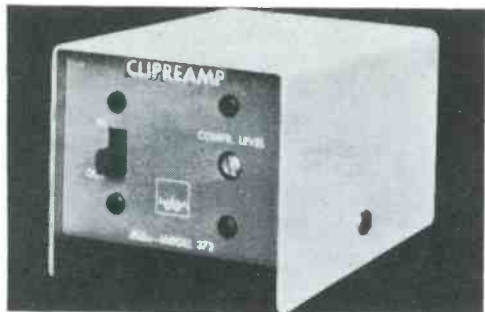

control that may be adjusted with a screw driver for the optimum amount of clipping without excessive distortion. Once this control is set, readjustment should not be required and since there is no knob on the control, you can't accidentally knock the setting out of kilter.

Inside of the unit is a mounting clip and clip-on leads for installation of a standard 9-volt battery (Burgess 2U6, or equivalent—not supplied). On the rear of the unit is a strip with four screw-type terminals for the input and output connections, including the push-to-talk circuits. Installation of the Clipreamp may be made without the necessity of extra wires or any soldering. To do this, you simply cut the mic cable in two at a short distance from the mic plug, remove some of the insulation from the ends of the wires in each piece of the cut cable plugs instead, there are two  $\frac{3}{8}$ " diameter terminals according to the instructions, and you're all set to go. If you prefer to use

cable plugs instead, there are two  $\frac{3}{8}$ " diameter holes already punched at the back for the installation of suitable jacks.

Adjustment simply involves talking into the microphone and setting the *clipping-level* control at the point that produces a noticeable increase in signal levels over that obtained with the Clipreamp switched out. Too much amplification and clipping can cause excessive distortion or inferior modulation, so to be legal, adjustment should be made by a holder of a 2nd Class Radio Operator's license.

Besides raising the average power and improving intelligibility, the Clipreamp holds the over-all volume relatively constant, so you can wander around the mic without having to always hold it close to your mouth. The Clipreamp also may be used to advantage with other audio devices such as p.a. systems, recorders, etc., to maintain a high constant-volume voice level.<sup>1</sup>

The Waters Model 372 Clipreamp is priced at \$91.95, less battery. It is produced by Waters Manufacturing, Inc., Wayland, Mass. and is available from distributors and dealers throughout the U.S. and Canada.

1. Use of an external device, such as the Clipreamp with CB transmitters that already incorporate a speech clipper or compression (such as may be found in the Browning Eagle) may be of little advantage. Also, matching to transistorized gear most likely will present difficulties. Therefore, application in such cases is not recommended. Operation also is limited to high-impedance crystal or dynamic microphones. It cannot be used with low-impedance carbon mics.



**CITIZENS  
BAND**

*Crystals*

**are Precision-Matched for Hundreds of  
Transceiver Models**



**Z-9R**

PR now furnishes "precision-matched" crystals already coded for use in more than 400 of today's makes and models of CB equipment. By "precision-matched" we mean that the crystals not only match the circuit, but they have been tested in actual operation in each individual make and model.



**Z-13**

**EVERY PR CRYSTAL IS UNCONDITIONALLY GUARANTEED**

**PETERSEN RADIO CO., INC.** 2800 WEST BROADWAY  
COUNCIL BLUFFS, IOWA

# CB CHIT-CHAT

**INDIVIDUALS AND CLUB MEMBERS!!  
SEND US ITEMS FOR THIS COLUMN!**

Address correspondence to:

**JOHN KREJC, KB18077  
60 DIVISION AVENUE  
GARFIELD, N. J.**

## **AREA PUBLIC RELATIONS EDITOR BULLETIN BOARD**

**Newly appointed A.P.R.E.'s include: Steve Lenaghan, XM41-3710, REACT, Trent Valley, Box 191, RCAF Station Trenton, Trenton, Ontario, Canada.**

## **COMING EVENTS**

Sunday, November 14th, the Lincoln Trail CB'ers, Inc., will hold their 3rd Annual Hootenany, Moose Hall, Paris, Ill. Contact: Walter L. Jones, 221 N. Austin Street, Paris, Ill.

## **WESTERN**

The Denver Metro CB Radio Club has elected the following new officers: President, Frank Chaney, KGC-0434; Vice President, Bud Fuller, KLE0978; Treasurer, Bill Ross, KGB0665 and Secretary, Herb Brown, 15W-1898.

It was learned that the skip was in during the emergency operations when Denver was flooding last June. Members of the Fresno CB Radio Club, Fresno, California, heard a good deal of the emergency operations during the periods of skip and through their own resources gathered up 58 large boxes of household goods, food and clothing which they sent to flood victims in the Denver Metropolitan area. This is the first time that I have heard of skip being other than a nuisance. The large shipment was transported from California to Colorado free by the Ringby Truck Lines.

The Mountain Airs CB Radio Club of Colorado Springs once again enjoyed the hospitality, entertainment and door prizes at the Saturday Night Coffee Break with the Denver Metro CB Club.

A combination Practice Exercise and Demonstration was held by the Mountain Airs CB Radio Club incorporating all of their available search and rescue equipment to include an air drop. Visiting CB'ers and local news media took the opportunity to see what this organization was capable of doing in emergencies. In connection with their search and rescue program, the club is currently undergoing training in the Medical Self Help Program as administered by the Office of Civil Defense. The course is being taught by one of the club's own members, Tom Leakey, KLE2818. When Tom took the instructors course a few weeks back he obtained the second highest score on the test for this area. The club is fortunate to have him as a member and special instructor.

Attention Eastern Slope CB'ers in the 15th Call Area. Please contact your Area Public Relations Editor. Clubs, would be clubs or individual CB'ers. Write to Paul Schonstrom, KLE2450, 720 Duclou Street, Manitou Springs, Colorado.

**Certificate of Appreciation:** Utah Citizens Band Association, Salt Lake City Chapter, Inc. Received a certificate of appreciation for their participation in the Easter Seal Appeal. All those who contributed time, money and effort to this drive are to be commended and a hearty thanks to all. The certificate will be framed and will hang in the association meeting hall.

**Weber County CB Association, Inc. Elects:** A new up and going CB Organization that has just been incorporated in the State of Utah is the Weber County CB Association . . . They have a Newspaper known as the W.C.R.A. Filter, news from this source will be forthcoming in the future each month.

A new election at this activity resulted in the following officers for the coming year:

President, Lloyd Bute, KGC0443, 5263 South, 2050 West, Roy, Utah; Vice-President, Don Dutro, KGC-1930, 4497 South, 2075 West, Roy, Utah; Secretary, Darrell Orem, KGB1802, 4760 South, 2025 West, Roy,



A radio-dispatched reverend? The Rev. Tyson L. Hope of Windsor Park Presbyterian Church, Bradenton, Fla. has installed two CB units, one in his car and one in his home, so he can be reached whenever he is needed by his parishioners. Mrs. Hope, who doubles as church secretary, can reach him almost immediately if the need arises.

The minister is licensed by the FCC and has been issued the call letters KMP2581.

"Instant coffee, instant tea, and now instant preacher" laughed one church member. However it has been no joking matter when the pastor has been needed for church emergencies such as accompanying parents of sick children to the hospital or talking with potential suicides—and he can't be reached. A minister needs to be available to his membership when personal crises arise, and Mr. Hope has arranged to make this possible.

Mr. Hope has been interested in radio for some time, and was a radio man in the service. He has also been a supporter of the use of mass media by the church.

Utah: Treasurer, Roger Sorenson, KGC0492, 2457 North, 575 East, Ogden, Utah.

CB Clubs in the State of Utah . . . namely, those of Utah County, Weber County and Salt Lake County . . . Any unknown active clubs please submit their club elections, information and club newspapers, each publication to APRE Junius H. Noyes, KLE0928, 52 South 1st West, American Fork, Utah for the Utah area.

**SIDEWINDER CB RADIO CLUB 10/20** Chanalake and Ridgecrest, California. Official request for assistance of the club to handle the necessary communications connected with the **DESERT EMPIRE FAIR, 10/20, Ridgecrest, California** was received by Mrs. Addie Suladie, KFA6269, Club Sec., and passed on to club members at the last meeting. This will be the 3rd consecutive year that the "SIDEWINDERS" have answered this call. This year it is planned that 10 teams of 2 units each will be necessary in order to handle the needs of "Parade line up," Ch. #11 will be used. The club welcomes any and all exchanges with other clubs plus direct letters and inquires to P.O. Box 5053, Chinlake, Calif. Zip 93556.

**MOUNTAIN AIRS CB Radio Club, 10/20 Kernville, Calif.** Nestled in the heart of the Greenhorn Mountains is the most friendly group of CB'ers that this A.P.R.E. has had the pleasure of contacting. This club has been organized since Feb., 1964. Dues are \$5.00 per year per family. Meetings are held twice monthly on the 2nd and 4th Saturday. Membership is wide spread, approximately 30, some of the members travel as far as 100 miles to attend meetings. Present officers are: President, Mary Looy, KFB0376; 1st Vice President, Tom Frazier, KFA1490; 2nd Vice President, Evert Beatty,



What is Master Mobile So  
Excited About! . . .

## 2 NEW REVOLUTIONARY ANTENNAS NEW! DDDR\*



**VERTICALLY  
POLARIZED  
LOW PROFILE  
MOBILE  
ANTENNA**

MODEL CB-42  
CB 11 Meter 27MC

The DDDR Antenna has been designed to incorporate the electro-magnetic efficiency of naturally resonant quarter-wave whip antennas with a low profile which can be easily installed on vehicle roof tops and precisely tuned over a wide range of frequencies.

Because of its unique design features, the DDDR Antenna will normally out-perform quarter-wave mobile installations, both in transmit and receive modes. CB NET \$29.95.

- VERTICAL POLARIZATION
- OMNI-DIRECTIONAL IN HORIZONTAL PLANE
- LOW PROFILE DESIGN
- EFFECTIVE INCREASE IN RADIATED POWER
- LESS NOISE FROM STATIC CHARGES

Other frequencies available from 27 to 180 mc

\*Licensed by Northrop Corp.

## NEW TOROID TENNA

is a super-efficient, compact mobile whip that measures just 42" in length. Toroid-Tenna's quality construction incorporates toroid transformer in base to boost transmit range; all brass and stainless steel; screwdriver adjustment for perfect VSWR (no cutting or trimming needed); weather/waterproof, chrome-plated base. Transformer and capacitor are completely shielded for noise-free operation. 27 Megacycle TOROID-TENNA: \$21.95 NET.



Dept. S9

Dealers Send for Complete Information and  
"ANTENNA BUYER'S GUIDE"

**Master Mobile Mounts**

4125 W. JEFFERSON BOULEVARD  
LOS ANGELES, CALIFORNIA 90016

AREA 213, 731-2251

DIVISION OF



KKX1728; Secretary, Jeanne Self, KFA7691; Treasurer, Bill Klahn, KFA9467; Sgt. at Arms, Lou Self, KFA3062. The club is strictly social, monitors Channel #9 as contact and 10/33—they are willing to switch to another Channel for 10/73's and chit-chat.

### ATLANTIC

Dateline: Oakline, Md. area . . .

The Preston County CB Club, Inc. of Tunnelton, W. Va., held a very successful CB family picnic on August 8, 1965 at Herrington Manor State Park. A good time was had by all. Plenty of food on hand for everybody. The grand prize awarded during the afternoon was a new Hallcrafters Walkie-Talkie. Many other prizes were awarded all day.

Live musical entertainment highlighted the day of activities. This club recently became incorporated in the state of West Virginia. It is a growing club and was formed in 1962. They monitor channel 11 in this area of Tunnelton and Kingwood, W. Va. The main purpose of the club is to assist anyone in need of help.

They are currently engaged in a drive to "curb" the illegal use of walkie-talkies in their area. The President of the club is Herschel Davis, Jr., KMI2172; Vice President, is Lonnie Shreves, KCF1308; Secretary-Treasurer is Patti Bucklew, KKI3960.

Anyone desiring more information on the club can write to: Preston County CB Club, P.O. Box 191, Tunnelton, West Virginia. They meet the 4th Tuesday of the month.

The Wine-Fred. County CB Radio Club is proud to report that it is now incorporated and we have been assigned our own call sign, KMI2234. Also we recently had a membership drive and we are growing all the time. Charlie Whetzel, "The Snow Maker," KKI0651, received a 10 transistor radio for recruiting the most new members.

We are proud of our Operation Standby Emergency Truck and Operation Standby Committee headed by Ray Marcus, KCG1833; they are standing by and ready to help all of the time. They have already performed many services to the public along with the other members helping. We monitor channel 11.

Officers for the year 1965-66: President, Lee Holler, KCF1042; 1st Vice-President, John Kerns, KCF2243; 2nd Vice-President, Bill Schuller, FCG1468; Secretary, Mrs. Andy Nethers, KKI3476; Assistant, Andy Nethers, KKI3476; Treasurer, Charlie Whetzel, KKI0651; Assistant, Mrs. Whetzel, KKI0651; Chaplain, Kenny Unger, KKI2357; FCC Advisor, Jerry Hand, KCG0275; Sgt. at Arms, Elmer Lauck, 4W2486.

The Tri-County CB Radio Club, Inc. of Martinsburg, Pa. area recently held a very successful CB jamboree at Trough Creek State Park. There were displays of all types including an S9 Magazine display set up by APRE Dick Long of Cumberland, Md. Many nice prizes were awarded during the afternoon. Music provided by the Patriots was the highlight of the afternoon. Lots of QSL cards were swapped! Plenty of refreshments were available. All types of recreational activities were conducted. Trophies were awarded for special awards at the end of the day's activities.

They are already formulating plans for a bigger and better CB jamboree for next year. Watch this column for more on this one.

### NORTHERN

Newly reporting is the Interstate Courtesy Ass'n, about 1 year old with about 50 members. The Ass'n hails from Delaware, Maryland and New Jersey and was formed to do just what the name implies, give communication assistance to anyone within its reaches. Officers include: President, William Dulin, KKG4414; Vice President, Dave Petrucci, KKG4482; Secretary, Nancy Miller, KCC2165; Treasurer, Roy Kitchens, KKI-2623. Monthly meetings are held at U.A.U. Union Hall, Marshallton, Delaware, every 4th Sunday at 2 p.m. All interested CB'ers are welcomed.

The Pioneer Radio Citizens Band Ass'n wishes to thank all Radio Clubs and individual CB'ers from outside the State as well as those in New York, who attended our Parade of Bands Jamboree, held on the 30th and 31st of May.

Since the Clubs only interest is raising funds to help retarded children, Our Motto is "We pave the way for Youth to follow." Many of you played a big part in making it a big success.

We hope to see all of you at our next Jamboree. We hope to make it as big and definitely as good as the last one was. Thank you all again.

When experience counts, it's S9 every time!





The Vienna Citizen Band Radio Club Inc., recently held their elections and those elected for the year 1965 were: President, Bob Runion, KHG2492; Vice President, Bill Owens, KH16504; Secretary, Betty Martin, KHH16B4; Treasurer, Sue McCauley, KHJ6011. Meetings are held the 1st and 3rd Monday of each month at the Wayside Parrish House on 30th St. in Vienna, W. Va. Any club wishing to correspond with us, our mailing address is P.O. Box 5144, Vienna, W. Va. We are now up to 46 members at the time of this writing and growing every month. Recently our members were entertained with a swimming party held at our local pool and a splashing good time was had by all. Several events are planned for the winter months and all CB'ers are invited to attend our meetings as the prime goal of our club is to become a centralized point for information resources and services for the Citizen Radio Licensee's in this area. It is intended that the point may be reached where any service required to be a Citizen Radio Licensee may be obtained from, provided at, or coordinated from this one central point. Here's looking forward to some correspondence from other clubs and we will try and answer all.

#### CENTRAL

First Jamboree Announcement of the Year—May 22, 1966, the Five Watt Wizards CB Club of Chillicothe, Missouri, will hold its Fourth Annual Jamboree at Pershing Park, Chillicothe. Put it on your CB event calendar now. The 1965 Jamboree was attended by over 400 CB'ers and the club hopes to push the attendance record to a new high next year.

DownRiver CB Club is in its fourth year. We have 96 members at this moment but by our next meeting this month it will probably reach its limit of 100. We hold our meetings on the second Sunday of the month at 7:30 p.m. There are two main projects each year—a picnic and a Christmas Dinner. At our picnic this year we had over 450 people and gave away over 60 prizes. We usually have an extra social gathering each month besides our regular meeting and board meeting.

The following is a list of our club officers: Dewey Harris, KH19150, President; Chuck Koteles, KLM5797, 1st Vice-President; John Kennedy, KLM3902, 2nd Vice-President; Mary Koteles, KLM5797, Secretary; Orville Austin, 19QA0110, Treasurer; Ken Malenfant, KIA-0511, Sgt. at Arms.

The Ozark Citizens' Band Radio Club has recently elected new officers. Pres., Clifford Motley; Vice-Pres., Harold Weiss; Sec., Tom Marler; Treas., Ferral McCord. Although the Ozark Club had a few setbacks over this year their membership has now climbed to 35 and new members are coming in all the time.

**NOTICE:** Any Missouri CB Club interested in joining with the Mo. State Citizens Band Club, please contact Hurlless King, P.O. Box 525, Chillicothe, Mo. 64601. The newly organized State wide group is anxious to be in contact with all parts of the state. They have now held two well attended meetings and are planning their third meeting, Sept. 19 in Sedalia, Mo. Let's try and make this effort a success and get all CB clubs in Missouri allied with one another.

The North Area Emergency Radio Team, again aided the Boy Scouts of Clay County Missouri by providing communication and first aid for a 100-mile bicycle ride made by the boys to Weston, Missouri and back. The N.A.E.R.T. has provided a great community service to

**KAAR MOVES CB  
AHEAD 5 YEARS  
...OVERNIGHT**



# KAAR SKYHAWK

**335**



- **HAND-SPAN COMPACTNESS**
- **ALL SOLID STATE**
- **23 CHANNELS** (no limit on channel choice)
- **2 YEAR GUARANTEE**

If you've been waiting for the CB transceiver that has everything . . . move up to SKYHAWK!

**YOU GET ALL THESE SKYHAWK  
FEATURES NOW...No Waiting**

- Tantalum capacitors
- Sealed-plug in relay
- Filtered power leads
- Paging
- External speaker jack
- Illuminated signal level meter with dynamic modulation indication
- Glass epoxy circuit board
- Provision for plug-in selective call
- Amplified Zener diode voltage regulator
- Fine tuning (Varactor-technique) on channel selector
- External metering socket
- Inter-station and system channels identified
- Smart chrome and charcoal gray epoxy finish

**199.95**

complete with power cable, mounting bracket, crystal for channel 9 "Help" Channel

\*OPTIONAL

6 pack crystals (for Channels 10-11-12-13-14-23) **19.95**

22 pack crystals — all 23 channel operation

**69.95**

FCC STATION LICENSE REQUIRED. ALL USE MUST CONFORM WITH PART 95, FCC REGULATIONS.

**KAAR ELECTRONICS CORPORATION**

Member: CANADIAN MARCONI COMPANY Group



2250 Charleston Road • Mountain View, California

**S9 = more news, more authors, more value!**

# 23'er...



## the finest Citizens Band mobile transceiver...

The 23'er twenty three channel, all transistor Citizens Band transceiver is the choice for any mobile application — car, truck or boat — because only the 23'er has the Squires-Sanders Noise Silencer. This exclusive device virtually eliminates interference due to noisy ignition systems and saves up to \$35.00 in installation expense for ignition noise suppressors. Weak signals are clearly intelligible on the 23'er under electrical noise conditions that would make the ordinary transceiver almost helpless. The 4 watt audio output and the large 3 x 5" front facing speaker are important features for mobile use also, to provide powerful voice reproduction that can be understood over the background of highway tire noise and wind whistle.

The ultra sensitive 23'er receiver (number one in a recent impartial test of the currently available transceivers) is a must for mobile — weak signals can be heard clearly for greater distances.

Compare just some of the other outstanding features of the 23'er and be convinced that it is the only unit for your mobile installation:

**ALL TWENTY THREE CHANNELS** — complete coverage of both unit to unit and station to station communication channels

**ALL SILICON TRANSISTOR** — the least battery drain

**SMALL** — it fits anywhere, even in the compacts

**LIGHT** — weighs only 4 lbs.

**SIMPLE TO OPERATE** — only three controls

**COLOR CODED CHANNEL DIAL** — specially marked for read-at-a-glance identification of channel 9 (H.E.L.P.) and legal station to station channels.

**PUBLIC ADDRESS AND REMOTE SPEAKER** — Provision for converting to Public Address service with a small, inexpensive accessory and provision for plug-in external speaker for either CB or PA service.

**PRICE** — You will save over the cost of less expensive equipment since all crystals are furnished and no ignition suppressors are required. **READY TO OPERATE \$235.** AC Power Supply for base station operation \$24.50.

See your distributor today or write to 23'er Department

## Squires-Sanders, Inc.

Millington, New Jersey 07946



**SPECIAL OFFER:** If you would like an 8 x 10 glossy photo of the 23'er and a shirt pocket size call book to record frequently contacted station call signs, send 25¢ with your request for information.

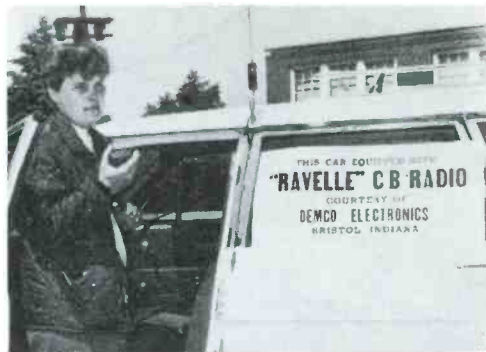

"WAGONS HO!" is the call being given by Miss Judy Farmer, "wagonmaster" and teacher at Edwardsburg, Michigan, who is leading 34 junior high school pupils and adult chaperones traveling in eight autos on a 3,275 mile trip through the U.S. and Canada.

The entire caravan is equipped with new "Ravelle" CB radios supplied by Demco Electronics of Bristol, Indiana. Not only will they be used to keep the caravan together, but will supply communications with the "outside" while camping in the remote areas to be visited. Their itinerary calls for visits in Nova Scotia, Maine, New Hampshire, New York and return.

It is expected that experiences of the trip will be used to promote the H.E.L.P. program initiated by the Automobile Manufacturers Association for a network of emergency CB communications.

Miss Farmer is an experienced leader of this type of touring by students, and success of her ventures has attracted the attention of a number of educators interested in similar educational tours.

all groups in the Clay county Missouri area this past five years and is one of the old timers in the K. C. area CB world. They recently began using and monitoring Ch. 12, and can be reached for emergency service 24 hrs.

On August 1, the CRYSTAL WIZARDS of Muskegon, Michigan held their monthly meeting at Slovak Hall.

Guests were Gary Young, KNM992R, of Muskegon Heights, and Pat Stevens, editorial assistant of the "Michigamme Trails."

Radios on display included a Webster transistor 5-channel rig with exceptional compactness; and an all transistor Squires-Sanders 23-channel rig. Both were furnished by Electronic Distributors of Muskegon.

Officers present: President, Doc Blood, KNM2473; Vice President, Ralph Hern, KLO2466; Director of Activities and Publicity, Orville Bluhm, KLN9961; Max Hern, 19Q1178 substituting for the usual Secretary-Treasurer; Refreshment Chairman, Levina Murdzia, KH13084; and Health and Welfare Chairman, Dot Blood, KNM2473.

S9 APRE Donald R. Shue, KKG4329, was recently appointed chairman of the Public Relations Committee for the York County, Pa., REACT. Sterling Tyson, KKG4328, and Cliff Ramble, KKG3932, complete the committee. Executive officers are Charles Rosier, President; Larry Freed, Vice President; Robert Cook, Secretary; Erv Ness, Treasurer and James "Shorty" Wedlock, Asst. Treasurer. Tyson also serves as Sergeant-at-Arms. Jack Strayer is Chairman of the Board of Directors. Other board members include Ed Mummert, Lew Klinedinst, and Elwood Lefever. York County REACT, Inc., monitors ch. 9, 24 hours a day. Mailing address is York County REACT, Inc., Post Office Box 324, York, Pennsylvania. Meetings are held the fourth Sunday of each month at various meeting places.

The York CB Assistance Club recently received its station license with the call-sign KMG2787, which will be used, in addition to the individual member's membership number, in all club activities. The club handled communications at the Pennsylvania State Firemen's Convention Parade to be held in September and will provide communications at the annual Halloween Parade in late October. The 1966 Jamboree is currently being planned under the chairmanship of George J. Chantiles, 3Q3211. The Jamboree, for next year, will take on a "new" look, in-as-much as it will be a CB

Electronics affair with CB companies and distributors as well as other companies dealing in electronic equipment will be invited to display their wares at the '66 Jamboree. The Jamboree plans, in addition to the above information, are coming along. York CB Assistance Club address is Post Office Box 814, York, Pa. The meetings are held the second Saturday of the month at Spurg's Drive In, 2266 S. Queen St. at 8 p.m.

Irvin Renoll, KCC0779, is serving as unit commander to the Pennsylvania Rangers. The Pennsylvania Rangers is an organization consisting of horses and their riders who serve the York County, Pa., area as a mounted rescue squad. Although a few years old, interest was renewed recently as a rescue unit. CB is used in their operations and the group has applied to the FCC for their own license. Other members who hold CB licenses are Charles H. Small, KCD1217 and Gary Paules, KCC2807. The Rangers do quite a bit of riding and hold mock rescue operations regularly. Their primary function is to enter areas where motorized vehicles are limited. This APRE has been invited to witness some of their activities.

On August 10th The Virginia Beach CB Club Inc. voted into office for the next term, the following officers: President, Joe Holloway, KKK2856; Vice-President, James DeLong, KMK1859; Secretary, Catherine Winkler, KCJ6128 and Treasurer, Thomas James, KMM1870.

August 12th at the Norfolk CB Club meeting at Priest Electronics in Norfolk, Virginia, newly elected Civil Defense Co-Ordinator, Al Crane, asked that anyone interested in becoming active in this organization please contact him.

New members for TERRAC of Norfolk, Virginia this month are: Fran Poythress, KKK7454; Judy Bismark, KKP2521; Pat Click, KKD4493; Al Crutchley, KKK-6384; and Marshall DuBois, KDI0238.

Elected to fill the office of Vice-President of the Portsmouth CB Radio Club Inc. was Ernest Hawkins, KCJ4795. The club welcomed new members Guy Gaskill, KKK2771 and Phillip Roddy, Jr., KMK1693.

News of the Tidewater Virginia clubs is from APRE Bob Smith, KKK6249.

My heartiest congratulations to fellow APRE John March, KCG2967 on his recent election to the Presidency of the Virginia State Citizens Band Radio Association, Inc. We know that under his leadership the association will grow to be the best in the country.

The recent fire on Bolivar Road served to point out how well CB Radio can be utilized to assist communications in a difficult situation. The fire was declared a disaster area by C.D. Director Bob Coulter. CB Communications were under the direction of Jim Cicirello. The area was ringed with mobile units at each intersection. Mobiles were used at the locations of ambulances and first aid teams. Portables were used as talkers for Police Chief Fiordo, Director Coulter, Mayor Gardner, and the Rescue Service. Channel 14 was cleared for only emergency traffic for over eight hours while CB'ers assisted by passing messages between departments, directing traffic and tying together communications of fire departments, village police and state police. In addition to the ten or so regular C.D. radio communications people on the scene, many other CB'ers arrived to volunteer their time and equipment to assist with problems at the fire.

The Northern Berkshire Emergency Communications Club, Inc., Adams, Massachusetts, held its First CB Radio Jamboree at Anthony's Pond, West Road, on Sunday, August 29th.

About 600 CB'ers converged on the Jamboree site starting their migration to the area on Saturday afternoon. Many units came directly from a New York Jamboree. Cars came from near and far with New York license plates predominant in the parking lot. The camping grounds were well filled. Some of the campers were still being guided into the area at 2:00 a.m. on Sunday morning. Albert Abraham, KKA3377, (Club Vice-Pres.) was up pretty late assisting Jamboree Control.

Very prominently parked for all to see, was the Emergency Truck and Searchlight Trailer owned and operated by the Jamboree sponsors. This vehicle has been used many, many times this Summer for emergency situations. Northern Berkshire Emergency Communications Club President, Bud Miller, KBC1831, has driven this unit many miles on its errands for the surrounding communities.

Present at the Jamboree was a CB lapel pin Engraver, a White Elephant Table, Attic Treasures booth,

Snack bar, and Refreshment stand. S9 had its display and subscription table for the convenience of CB'ers too! (S9 APRE, Mike La Versa, KKA4462, met loads of nice people all day.

**THE BOWLING GREEN WARREN COUNTY CITIZENS BAND RADIO CLUB, INC.** announces the election of officers and board of directors at the July 8, 1965 meeting.

New officers are: President, Wilson Stewart, KNJ-4762; Vice President, Floyd Hazelrigg, KNJ0868; 2nd Vice President, Lewis Hire, Jr., KKK5650; Secretary-Treasurer, Hope Hayes, KKK4326.

Members of the club recently aided the National Campers and Hikers Association with communications at their 6th annual "Campvention" held at Beech Bend Park in Bowling Green, July 12 through 16.

On the night of August 27th, 1965 at approximately 2050 p.m., Lorain and Cuyahoga Counties were on a Tornado Alert standby. The Lorain County REACT Headquarters along with Cuyahoga County REACT Headquarters declared Channel 1 (One) as the State Emergency Channel and all traffic was asked to move to another channel for other chit-chat. We did experience winds of up to 60 miles per hour, large hail, lightning, and pouring rain for both counties. A funnel cloud was sighted in Sandusky, Ohio. Other alerts went up for all of Ohio as well as Pennsylvania. Thanks to KHI1466, director, REACT Coordinator for Cuyahoga County for the 10-5 messages to all units concerned standing by on channel 1 for that evening. Again we wish to thank the other local CB'ers who stayed off of channel 1 during the tornado alert. All REACT teams in the Ohio area were well prepared and ready to go at any time during the storm. Fortunately, all we had was the heavy rain and winds during the evening. All units were secured at approximately 2405 when the alert was over for Lorain and Cuyahoga Counties.

News of the REACT teams comes from: Jon G. Batley, KHI1466, S9 APRE for Ohio.

All Kansas City, Missouri CB Clubs were called to a meeting with the K.C.P.D. for the purpose of setting up "Operation Barriert." The area CB'ers have been so helpful to the community the law enforcement agencies

## Solid-state CB mate

The best way to ring up more 10-2s with the new solid-state transceivers is by using one of the new low-impedance Sonotone Ceramikes®. They are designed specifically for all-transistor transceivers. Transmission is loud and clear, and Ceramikes are built to take abuse. Get the low-impedance "CM-3050" or the "CM-3050M" with Magnetic Mount, today. Also Models "CM-30" and "CM-30M" for tube transceivers. Prices start at \$15.75. Write for Free catalog SAH-7.



Sonotone Corp., Electronic Applications Div., Elmsford, N. Y.



# HALT!

## CB'ers & CLUBS! CH. 9 DECAL ONLY 50¢ ppd.

Get this big, easy-to-see, 3 color Channel 9 Monitoring decal for your car window! Boost better communications on CB by pushing and using Ch. 9 as the National CB Calling and Monitoring Channel. Immediate delivery. Only 50¢ each, bulk orders of 10 or more, 30¢ each. Dealer inquiries invited. Order NOW from:

**Channel 9  
S9 Magazine  
14 Vanderventer Avenue  
Port Washington, N. Y. 11050**

felt they would prove more useful if a set of established rules of operation were drawn up. Plans were discussed for combining Police and CB communications into an effective unit of observation. The CB'ers will receive alerts and they will act as observers only, they will never attempt to take the place of the Police officer or place themselves in a line of danger. The only real problem now seems to be the 24 hr. monitor and what channels to use.

The Missouri Valley Breakers of Raytown, Mo. have just finished printing their 1965 call book. It includes the names, 10-20 and call letters of Missouri CB'ers, and the club is interested in getting them into the hands of as many CB'ers in their locality as possible. This is the first call book of this area and much congratulations are in order for Dale Foster, KG13934 and Harold Gross, KG17138 for their long hours of work on this fine effort. Plans are being made for the 1966 Call Book and any interested advertisers as well as CB'ers who wish to be listed in the next edition should contact Dale Foster, P.O. Box 91, Belton, Missouri. If you live in Missouri let Dale know your name, call signal and 10-20.

The Sedalia Missouri CB Club is starting its drive for collecting goodies for the family they adopt each year for Christmas. It seems a bit early to be thinking about Christmas but the early start insures them of having everything collected by Christmas time. If you wish to be of help by giving them a hand contact Wright Rank, Herb Martin, John Heineman or Glen Heet of Sedalia, they will welcome your contribution.

The Tri-County Citizen's Band Radio Club, Inc., was first formed in November of 1962. Ray Dunkel of Martinsburg and Denver Shoenfelt of Roaring Spring called the operators from the two towns together hoping to form an organization to help each other and the communities. The meeting was held at the Eldon Inn in Roaring Spring with about twenty operators attending.

During the early days of the club it was known as the Cove CB Club. Later on operators from the Saxton and Broad Top area began to join and it was decided to change the name to the present one, Tri-County Citizen's Band Radio Club, which would take in parts of Blair, Bedford and Huntingdon Counties.

**S9**

# NEW! NEW!

from PEARCE-SIMPSON  
6 CHANNEL TRANSISTORIZED CB

The **SENTRY**  
\$99.90



- Car keys show compact size — perfect for easy, under-the-dash installation
- Transistorized receiver and power supply — minimum power drain
- Excellent for use in the new Highway Emergency Locating Plan (H.E.L.P.)

**ALL SOLID STATE CB UNITS**

featuring exclusive HetroSync® Circuitry



**The DIRECTOR**

23 Channel \$299.90

23 channel operation — all crystals included.

• *Eye-glasses show compact dimensions of The Director—and Escort II*

• *All solid state—uses less current than a dashboard clock—on the air instantly*

**The ESCORT II**

11 Channel \$239.90

Mono-crystal circuitry — uses only one crystal per channel instead of the usual two — cutting crystal costs in half.

PEARCE-SIMPSON, INC.  
P.O. Box 800 Biscayne Annex  
Miami, Florida 33152

Please send full information and model specifications.

Name .....

Address .....

City .....

State .....



**PEARCE-SIMPSON, INC.**  
MIAMI, FLORIDA



# S U Z I E S E Z . . .

**SEND ALL ITEMS  
AND PHOTOS TO:**

**Suzie Sez**

**% S9 Magazine**

**14 Vanderventer Ave.  
Port Washington, N. Y.**



**by SUSAN HENRIKSEN**

**Assistant Editor**

Here it is gals! In our August issue, old "blue beard," Tom Kneitel, asked for any items about your club activities, weddings, births, or just plain CB gossip that might interest our readers. Well we've been swamped with mail from all over the country. We even got one from South America! We will print as many of these items as space permits.

We would like to start off by congratulating the following CB'ers on their recent marriages. They are:

Janice Strange, ex-KDH0958, and Pedro Seidemann, YY5P279; Janice and Pedro plan to make their home in Caracas, Venezuela.

Gail Hamlin, KKK0742, and Ron Lovern, KKK8094, who were married on April 9, plan to live in their hometown, Salem, Va.

Also from Virginia are John Broaddus and Georgia Johnson, KCJ7278; Don Callans and Barbara Lacy, KCI6595; David Jenkins and Stefanie Berroughs, KMK0518.

We wish you all much happiness and hope you will let us know of any more news out your way.

Congratulations are also in store for Ginger and Richard Gearheart, KKK6817, on the recent birth of their baby girl. Richard and Ginger are from Richmond, Va.

Darlene Augustine, KNH0674, of Junction City, Kan., sent us an interesting recipe for, "Popped Skip Cake," which she serves to her fellow CB'ers when having

coffee and reading S9. She asked us to pass it along to you. We hope you enjoy it!

- 6 cups popped corn (skip flour)
- ½ cup salted peanuts (skip shells)
- 1 cup shredded coconut (skip baking powder)
- 1 cup syrup (skip eggs)
- 1 cup sugar (skip soda)
- ½ cup light cream (skip water)
- ⅛ tsp. salt (skip pepper)
- 1 tbs. butter (skip shortening)
- 1 tsp. vanilla (skip chocolate)

Combine popped corn, peanuts, and coconut in a large bowl. Blend syrup, sugar, cream and salt in sauce pan. Cook over medium heat, stirring constantly, until mixture comes to a boil. Continue cooking, stirring occasionally, to a soft boil stage, when tested in very cold water. Remove from heat. Stir in butter and vanilla. Pour over popcorn mixture and mix thoroughly. Press into a buttered 10" tube cake pan. Let stand several hours or mix until firm enough to slice. You can put small candy gumdrops on top of cake for decorating.

Starting next month, and each month thereafter, we plan to have a special feature describing the activities of a YL club or individual. If you are interested in letting others know about yourself or your club, or if you know of someone you think deserves recognition, send us a short description of the person or club activities.

Till next month . . . Suzie.



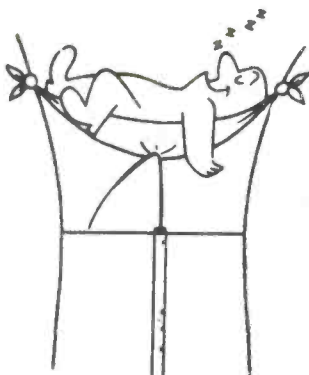

# ANTENNAS

by LEN BUCKWALTER, KBA4480

## HOW HIGH IS GROUND?

There are plenty of razzle-dazzle antennas to choose from nowadays. But for some reason the good old ground plane for base operation still has its share of supporters. One guess about its popularity: it does a fairly good job and is cheap. But like betel nuts and model airplane glue, its got to be used correctly for maximum benefit.

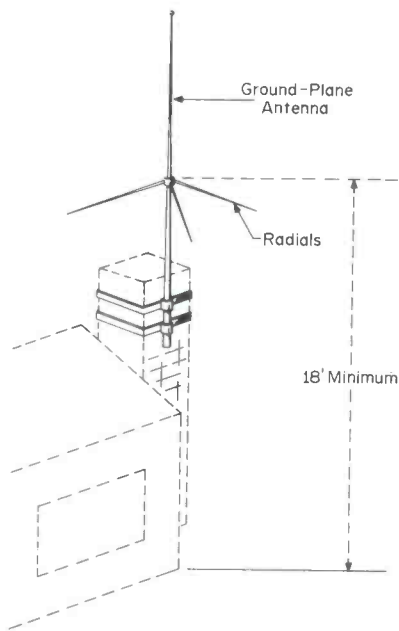

As most antenna-watchers already know, a basic antenna measures one-half wavelength—18 feet in CB. But it is also possible to make the earth act as 9 feet of this length. Thus a quarter-wave antenna—9 feet—just above the earth acts for all the world like it's 18 feet long.

But planting a 9-foot whip on the ground doesn't permit radiation to clear obstacles. And, as one antenna wizard once said: "It's easier to raise the ground than to lower the hills." This explains why the ground-plane antenna has a 9-foot vertical with a skirt of radial wires spreading outward at the bottom. Those radials

simulate the effect of earth ground—only now it can be any height. Or can it?

In a typical ground-plane antenna, radials are also 9 feet long. Thus vertical whip and radials bring the antenna back to 18 feet long, the basic half-wave. Several radials are needed to keep the antenna pattern from becoming hopelessly warped. Now for the kicker.

Although the ground plane creates the equivalent patch of earth, it must be *above* the earth to do this. Trouble is that real ground (earth) and artificial ground (radials) begin to interact when in close proximity. This can be avoided by mounting the ground-plane antenna at least one-half wavelength—which is 18 feet—above earth ground. At this height (or higher) the radials provide a fine ground path required by the signal—and eliminate a trip through actual ground, which generally produce losses.

## GO FLY A KITE

Shortwave listeners today have it all knocked up. Just toss out a piece of wire for an antenna and chances are signals will come pouring in. But it wasn't always that easy. The log of the world's first shortwave listener tells why. Unlike today's armchair adventurer, he ran into antenna problems that boggle the imagination. He proved that shortwave listening, at least during its early days, was no place for fat cats or the faint hearted.

First he selected a place to do his listening; not in a home—like a table in the bedroom—but a favorable location on the east coast of North America. His goal, like that of many of today's shortwave listeners, was to snare a European station. But the monitoring point had to meet strict requirements, mainly that it be on a cliff more than 100 feet high and that it overlook the ocean. After scanning a map, the most likely region seemed to be that curving arm of land jutting out from Massachusetts—Cape Cod. And the most likely point appeared to be a place called Highland Light. It stood on a bank 125 feet above the ocean.

But the natives in the area would have none of it. Since no-one at the time had any inkling of what shortwave listening meant, they shooed away him and his new-fangled receiving contraption.

Two other incidents suggest what people thought of shortwave way back when. One

quaint lady complained that the waves made her feet itch. In a more serious case, a man burst into a radio shack waving a revolver in the direction of the operator. Radio waves, he claimed, were causing him sharp internal pains. Fortunately the operator remained calm and offered the man a cure. If he would submit to an "electrical inoculation," this would produce immunity from the waves for the rest of his life. But to receive the inoculation, the man first had to remove all metal from his person—including the revolver, of course. The ailing man then submitted to the treatment—a rousing electrical shock. But he went away contented, apparently cured.

Now back to our pioneer shortwave listener. After the fiasco at Highland Light, he located a lonely spot near South Wellfleet on Cape Cod. It seemed the perfect antenna site—situated on a high bank overlooking the sea with no obstructions toward Europe. To insure success there was to be a mighty antenna installation. No less than twenty masts were erected, each 200 feet high. Each mast was fashioned from 100-foot lengths of pine lashed together. But not long after the installation was completed catastrophe struck. During a howling gale the complete antenna system was wiped out as if it had been constructed of matchsticks. One man narrowly averted disaster as one of the huge masts came crashing through the roof of the shack.

Our intrepid shortwave listener, however, was more determined than ever to hear Europe. As the ruins on Cape Cod were being repaired

(and you can still see them today at South Wellfleet) he journeyed northward to Newfoundland in search of another favorable listening point. He found it on a craggy plateau overlooking the sea, a place quite appropriately called Signal Hill (so-named for signalling ships by flags or lights, not by radio).

In the interests of speed, no antenna farm was erected, like the one just lost at the Cape. The antenna was to be raised by means of a kite or gas-filled balloon. Cylinders of hydrogen inflated balloons some 14 feet in diameter—large enough to loft an antenna wire weighing ten pounds. Again Nature played tricks. The first balloon escaped. The second one was seized by a gale-force wind, snapped its tether and disappeared out at sea. Next, the kites were brought out.

The scene began to resemble a Karloff movie: a stormy Atlantic raged nearby, wind howled around the shack, icy rain struck the face of the kite-fliers. But the kite surged upward and carried 600 feet of antenna wire with it. At exactly 12:30 in the afternoon, our man listened intently. What he heard were three sharp clicks. Over the next hour the triple clicks were heard to repeat some 25 times. Thrilling shortwave listening?

You bet it was. For this rugged shortwave listener was hearing the letter "S" transmitted over 2,000 miles from England—in the first successful reception of shortwave signals. The year: 1901. The man, world's first true shortwave listener and champion antenna raiser: Guglielmo Marconi.



Listen to the calls & know the news as it happens

## BE ON THE ALERT! with SONAR FM MONITOR RECEIVER



wired for "Tone Alert."

Model FR-101-(25-50 mc)  
Model FR-102-(150-175 mc)

**\$89.95**

TUNABLE RECEIVER  
AC Only

Slightly higher prices for DC and XTAL control

NOW!—8 Super Deluxe FM communication receivers to meet your particular needs for home, office or car. Powerful and dependable. Engineered for rugged service under all operating conditions. Featuring High frequency oscillator, temperature compensated for stability, RF amplifier for maximum sensitivity, illuminated dial, safety rated components and ALL Aluminum construction plus many other outstanding features. Operates on 110 VAC. Includes power cord, mounting bracket.



- Perfect for
- Police • Fire
  - Other Law Agencies
  - Tow Trucks
  - Civil Defense
  - Weather
  - Ship to Shore

### SONAR RADIO CORPORATION

73 Wortman Ave., Brooklyn 17, N.Y.

Dept: 428

Please send information on FR101/102 Monitor Receiver.

Name \_\_\_\_\_  
Address \_\_\_\_\_  
City \_\_\_\_\_ State \_\_\_\_\_

Better C-B Performance with

*Waters*

## AUTO-MATCH™



**4 db stronger  
MOBILE  
ANTENNA**

AUTO-MATCH . . . engineered to put out a stronger (up to 4 db) signal . . . built to last for years! Tapered radiator tip of stainless steel adjusts to all frequencies. Top-center loading coil is molded in Epoxy and completely sealed against moisture and seepage. High Q stable inductance presents an "Auto-Match" of 50 ohms at resonance. Lower mast is aircraft aluminum tubing — upper mast is solid tapered-drawn aluminum rod. Pull-up foldover hinge drops antenna to car top level. Auto-Match fits any standard mount.

**PRICE: \$34.85**

Includes all component parts and interchangeable 11-meter coil.

## CLIPREAMP™



**Triple your "Talk Power"!**

*Get into those fringe areas*

Give your C-B signal up to 4 times the talk-power and intelligibility with the Waters CLIPREAMP. Punch through the hash of QRM, get into fringe areas with this solid-state clipper-preamplifier. Compact and self-powered, CLIPREAMP connects externally between microphone and transmitter (mobile or fixed station) in just minutes. Front panel controls switch CLIPREAMP IN or OUT, OFF or ON and permit Compression-Level adjustments to individual requirements. Voltage gain: 10 db nominal.

**PRICE: \$21.95**

*(less 9v battery)*

## PROTAX™

**COAXIAL ANTENNA SWITCH**

with **AUTOMATIC GROUNDING**

Protect your rig with a PROTAX Automatic Grounding Antenna Switch. With a PROTAX you can operate at maximum efficiency with a choice of antennas: vertical, colinear, beam, etc., by simply switching from one to the other! The only coaxial antenna switch with grounding, PROTAX is available in two models: 375 with back connectors; 376 with radial connectors.

Model 375 ..... **\$13.95**

Model 376 ..... **\$12.50**

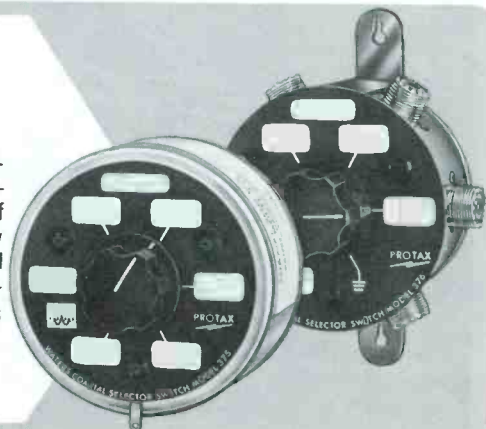

# WATERS

MANUFACTURING INC.  
WAYLAND, MASSACHUSETTS

**CB DEALERS:** Write to our sales department for complete information.





"Dual" Function Panel  
 AC DC  
 Delta Tuning  
 Channel Selector  
 Illuminated Meter and Channel Selector  
 "Noise Immune" Squelch  
 Double Tuned IF's  
 Compact 8" x 11" x 4 1/4"

**\$169<sup>50</sup>**

Ready to Operate



8 CHANNEL OPERATION  
 AC DC  
 Meter  
 Electronic Switching  
 2-Stage Preamp  
 Transistorized "Noise Immune" Squelch  
 Delayed AVC  
 Illuminated "S" Meter  
 Complete with Crystals for 1 Channel

**\$99<sup>95</sup>**

Ready to Operate

WRITE,  
WIRE or  
PHONE TODAY FOR  
COMPLETE INFORMATION



**MULTI-ELMAC COMPANY**

21470 COOLIDGE HIGHWAY OAK PARK 37, MICH.

Citi-Fone 55

Citi-Fone 99

Name .....

Address .....

City ..... Zone ..... State .....

CFRX, Toronto, Ont., 6070 kc/s at 0645 EST; *Voice of America Relay*, Monrovia, Liberia, on 7135 kc/s at 1700 EST; *Windward Island BC Service*, St. Georges, Grenada, on 3280 kc/s at 1715 EST.

Ronald Boisvert, Manchester, N. H. hears *Radio Kiev*, U.S.S.R., Monday and Thursdays to North America, on 9660, 9680, 9810, 11790 kc/s at 2030 EST. Also *Radio Ankara*, Turkey, at 1800 EST on 15165 kc/s.

Shack photo this month comes from Dave Lund of radio station KSCJ, Sioux City, Iowa. From the cards on the wall, we can see that Dave has been twirling the dials for many-a-year (he's got an ancient *Radio & TV News Magazine* monitor card—something we haven't seen since about 1950). Dave says to listen for HCJB, Quito, Ecuador, at 0200 EST on 9745 kc/s; *Radio Japan* at 0700, 0800, 0900, 1000, 1100, 1200 EST on 9505, 9740, and 11815 kc/s; *Radio New Zealand*, at 0100 to 0345 on 9540 kc/s and also 1500 to 0045 on 11780 kc/s; and finally *Radio Sweden*, 15195 kc/s from 0900 to 0930 EST. Dave uses an SX-99 to bring them in, although the set in the photo is an S-40—he's an announcer at KSCJ. Hope we hear more from him.

And what about you? Have we received a report and photo of your shack? Que pasa, baby?

**S9**

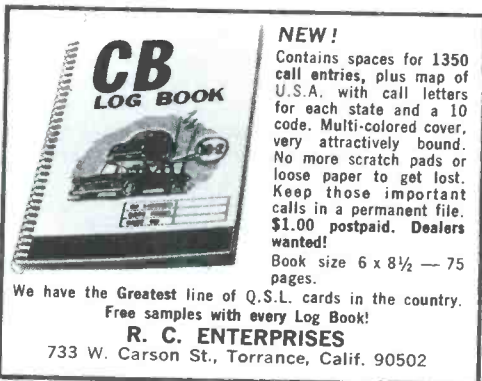

**NEW!**

Contains spaces for 1350 call entries, plus map of U.S.A. with call letters for each state and a 10 code. Multi-colored cover, very attractively bound. No more scratch pads or loose paper to get lost. Keep those important calls in a permanent file. **\$1.00 postpaid. Dealers wanted!**

Book size 6 x 8 1/2 — 75 pages.

We have the Greatest line of Q.S.L. cards in the country. Free samples with every Log Book!

**R. C. ENTERPRISES**  
733 W. Carson St., Torrance, Calif. 90502



## BEST BETS FOR LISTENERS ON THE DX BANDS

by RICK SLATTERY

Just as we promised you last month, this issue starts off our exclusive monthly listings of "unlisted" shortwave stations—stations which are often reported, but about which information is rare. This month's stations, of the U.S. Weather Bureau, are nice DX catches and most of them will QSL correct reports if you send them a stamped, self-addressed, reply card for them to sign and return to you.

We suggest that you start a DX guidebook with these S9 monthly rosters. Just cut the page with the listing out of S9 and insert it in a notebook. Be sure to spread the word of these lists among your DX friends.

Harry Nechetsky, KKP2504, Valpariso, Fla. passes along news of hearing stations ZNS, Nassau, Bahamas, on 1540 kc/s. Harry hears ZNS over WOKJ (1550 kc/s) and WBSR (1540 kc/s). He says to look for PJB, "Trans World Radio," Bonaire, Netherlands Antilles, on 800 kc/s. Try for it from 2100 until sign off at 0000 EST. Radio CMCA, Havana, Cuba, heard at Harry's 10-20 with English programs from 2300 to 0000 EST (they aren't in the clear until a Central American on 832 kc/s shuts down). Also look for XEG, Monterrey, N. L., Mexico, on 1050 kc/s with 100 kw. On shortwaves, Harry netted Madrid on 6130 kc/s at 1900 to 0400 EST; *Voice of The West*, Lisbon, Portugal, on 6185 kc/s, at 2200 EST.

Jim Burton III, Staunton, Va., to look for VLN25, a radiotelephone station in Sydney, Australia, on 10420 kc/s at 0915 EST. They don't have a regular schedule but will QSL if you write to Overseas Radio Terminal, 3rd Floor, G.P.O., Sydney, Australia.

A schedule from the Ghana Broadcasting Corp. was forwarded to us by Dick Clogston, KKA4210, Starks, Me. They have English to North America at 2330 to 0030 on 6110 kc/s, 1600 to 1700 on 9760 and 11800 kc/s (all



Here's a rare photo. It's the two 240 foot high transmitting masts used by the unlicensed "Radio America's" on Swan Island in the Caribbean. The station, which operates on 1160 and 6000 kc/s has been a thorn in Fidel's side for a few years now. So far as we know, this is one of the few photos ever taken at the station—since Swan Island is "off limits" to everyone.

times EST).

Brad Connors, Chevy Chase, Md., says to look for the following: TIHBG, *Radio Reloj*, San Jose, C. R. at 0700 EST on 6210 kc/s; *Radio Belize*, British Honduras, on 300 kc/s at 2200 EST; *Radio Santa Fe*, Bogota, Colombia, on 4965 kc/s at 0000 EST; XEWW, *La Voz de Antigua*, Mexico City, Mexico, on 6115 kc/s at 2300 to 0100 EST.

Bill and Danni Marple sent in an extensive report, from which we have selected the following tidbits: *Korean Broadcasting System*, 9640 kc/s at 0813 EST; *Radio Switzerland*, 9535 kc/s at 0144 EST; *Radio Berlin International*, on 9770 kc/s at 0345 EST; *Radio Presidente Balmaceda*, on 9600 kc/s, at 0130 EST.

Steve Jones, KLO0519, Lawrenceburg, Ky., says that good catches to look for include:

# "THERE WAS A CB'ER..."

by WILLIAM HAYMON, KBG5891

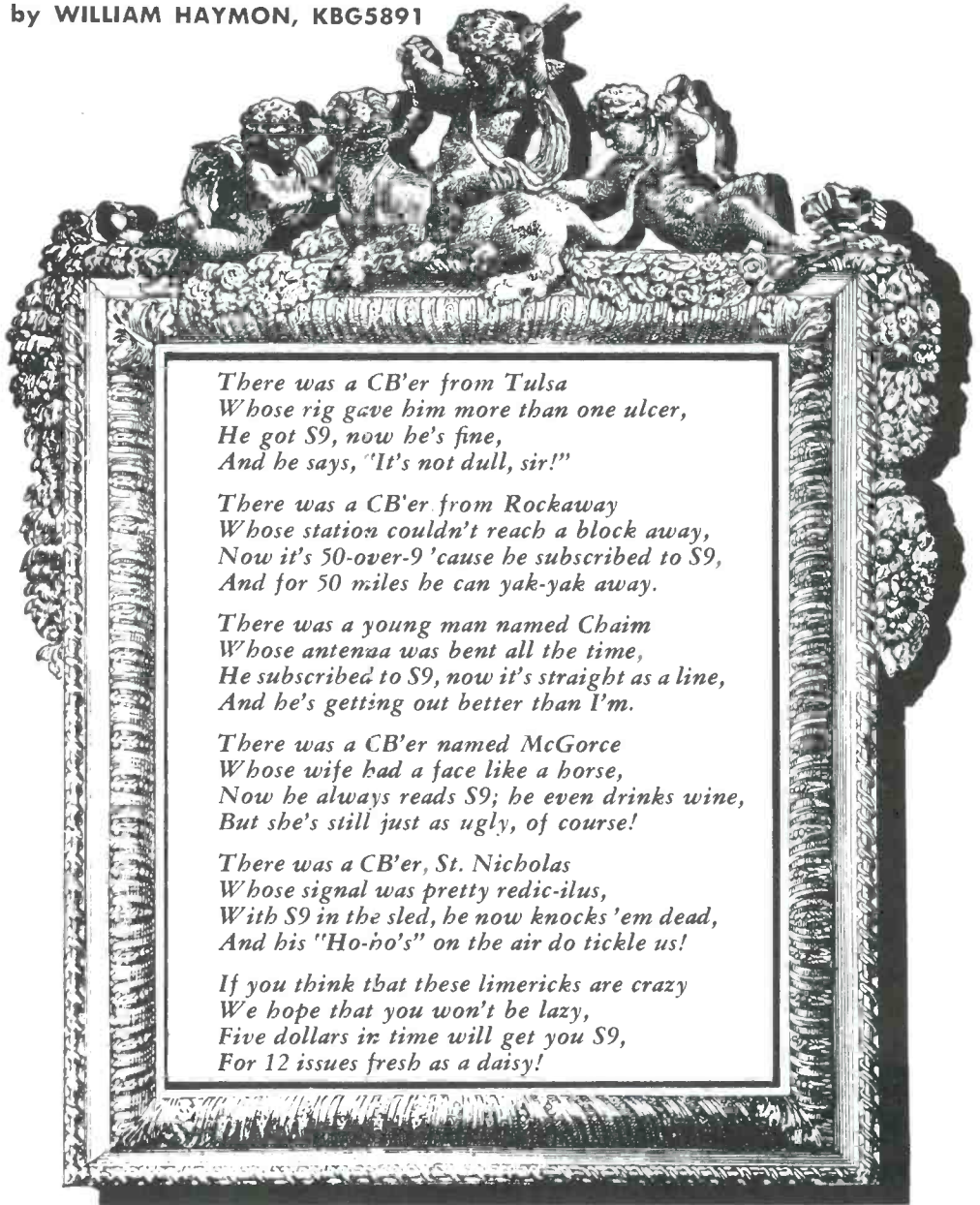

*There was a CB'er from Tulsa  
Whose rig gave him more than one ulcer,  
He got S9, now he's fine,  
And he says, "It's not dull, sir!"*

*There was a CB'er from Rockaway  
Whose station couldn't reach a block away,  
Now it's 50-over-9 'cause he subscribed to S9,  
And for 50 miles he can yak-yak away.*

*There was a young man named Chaim  
Whose antennaa was bent all the time,  
He subscribed to S9, now it's straight as a line,  
And he's getting out better than I'm.*

*There was a CB'er named McGorce  
Whose wife had a face like a horse,  
Now he always reads S9; he even drinks wine,  
But she's still just as ugly, of course!*

*There was a CB'er, St. Nicholas  
Whose signal was pretty redic-ilus,  
With S9 in the sled, he now knocks 'em dead,  
And his "Ho-no's" on the air do tickle us!*

*If you think that these limericks are crazy  
We hope that you won't be lazy,  
Five dollars in time will get you S9,  
For 12 issues fresh as a daisy!*

## HAPPY HOLIDAYS

# CARD SWAPPERS UNLIMITED

Hey Gang! David Thompson, IQ7422, is looking for QSL's from all over. Dave is Sales Manager of the Ray-Tel products division of the Raytheon Company, which puts out those snazzy little CB rigs used in conjunction with Project H.E.L.P. Let's swamp him under with QSL's. His 10-20 is Raytheon Company, 213 East Grand Ave., South San Francisco, Calif.

Swappers Awards are given to those readers who have sufficiently proven that they have reached certain specified levels of achievement in QSL card swapping. There are 19 different and distinctive Swappers Awards, and if you would like a complete set of rules, address your request together with a stamped, self-addressed envelope, to: Swappers Awards, S9 Magazine, 14 Vanderverter Ave., Port Washington, N. Y. 11050. Here are the winners of the black, red and gold certificates for the past month.

- SACA 263 J. Pfou, KLL0517, Chicago, Ill.  
 264 G. Wiles, KKB4015, Williamstown, Mass.  
 265 James Hill, KLJ5910, Marion, Ind.  
 266 J. McClure, KHI2703, Yawkey, W. Va.  
 267 C. Marx, KLF1859, St. Paul Park, Minn.  
 268 R. McMahan, KLV0247, Washington, D.C.  
 269 D. Delaney, KLK7493, Menomonee Falls, Wisc.  
 270 H. Turner, KNJ5199, Rushville, Ill.
- PX-25 522 L. Smith, KFA4077, Lynwood, Calif.  
 523 H. Justan  
 523 H. Huston, Jr., Kalamazoo, Mich.  
 524 C. Gagliano, KMD2453, Brooklyn, New York  
 525 R. Painter, KLM8694, Wyoming, Mich.  
 526 N. Schweitzer, KLM4519, Defiance, Ohio  
 527 C. Senatore, KKD3924, Newark, N.J.  
 528 Ed Fell, KNA2893, FPO San Francisco  
 529 J. Hill, KLJ5810, Marion, Ind.  
 530 H. Turner, KNJ5199, Rushville, Ill.  
 531 J. Revis, KMR1339, Benton, Ark.  
 532 G. Preiser, KKG4548, Collingswood, N.J.  
 533 M. Suintava, KKA6048, Bristol, Conn.  
 534 P. Bassiri, F2PE1k, Dover, N.J.  
 535 D. Delaney, KLK7493, Menomonee Falls, Wisc.  
 536 Noel Vander, New Bedford, Mass.  
 537 J. Myers, XM431853, Niagara Falls, Ont., Can.  
 538 Wm. Haines, KKI4574, Riverdale, Md.  
 539 Y. Tanaka, JA32520, Nishinomiya Hyogo, Japan  
 540 R. Berger, KNN1285, Columbus, Ohio
- PX-50 446 L. Smith, KFA4077, Lynwood, Calif.  
 447 Pat & Bill Parker, KNV0070, Washington, D.C.  
 448 H. Huston, Jr., Kalamazoo, Mich.  
 449 C. Gagliano, KMD2453, Brooklyn, N.Y.  
 450 R. Painter, KLM8694, Wyoming, Mich.  
 451 D. Sigo, CENT. 3250, Goodland, Indiana  
 452 N. Schweitzer, KLM4519, Defiance, Ohio  
 453 C. Colburn, KLK2881, Russellville, Ky.  
 454 Ed Fell, KNA2893, FPO San Francisco  
 455 J. Hill, KLJ5810, Marion, Ind.  
 456 H. Turner, KNJ5199, Rushville, Ill.  
 457 M. Suintava, KKA6048, Bristol, Conn.  
 458 Y. Tanaka, JA32520, Nishinomiya Hyogo, Japan  
 459 R. Maier, KLQ2438, Fort Plain, N.Y.  
 460 D. Delancy, KLK7493, Menomonee Falls, Wisc.
- 461 Noel Sandee, New Bedford, Mass.  
 462 Wm. Haines, KKI4574, Riverdale, Md.
- PX-75 346 L. Smith, KFA4077, Lynwood, Calif.  
 347 H. Huston, Jr., Kalamazoo, Mich.  
 348 C. Gagliano, KMD2453, Brooklyn, N.Y.  
 349 R. Painter, KLM8694, Wyoming, Mich.  
 350 C. Colburn, KLK2881, Russellville, Ky.  
 351 J. Hill, KLJ5810, Marion, Ind.  
 352 H. Turner, KNJ5199, Rushville, Ill.  
 353 M. Suintava, KKA6048, Bristol, Conn.  
 354 Y. Tanaka, JA32520, Nishinomiya Hyogo, Japan  
 355 D. Delaney, KLK7493, Menomonee Falls, Wisc.  
 356 N. Vander, New Bedford, Mass.  
 357 Wm. Haines, KKI4574, Riverdale, Md.
- PX-100 314 L. Smith, KFA4077, Lynwood, Calif.  
 315 C. Gagliano, KMD2453, Brooklyn, N.Y.  
 316 R. Painter, KLM8694, Wyoming, Mich.  
 316 R. Frost, KHA4980, Granger, Utah  
 317 C. Colburn, KLK2881, Russellville, Ky.  
 318 D. Cander, KNJ4430, Centralia, Ill.  
 319 J. Hill, KLJ5810, Marion, Ind.  
 320 C. Sisler, KNM2322, Mingo Junction, Ohio  
 321 Don Ebbeson, KNF0919, Paxton, Ill.  
 322 B. Lukonis, KKA8400, Wallingford, Conn.  
 323 M. Suintava, KKA6048, Bristol, Conn.  
 324 Easy Barber, KKR3294/2, Fort Smith, Ark.  
 325 Y. Tanaka, JA32520, Nishinomiya Hyogo, Japan
- PX-125 238 R. Painter, KLM8694, Wyoming, Mich.  
 239 Judge N. Littell, KNJ6056, Martinsville, Ind.  
 240 Y. Tanaka, JA32520, Nishinomiya Hyogo, Japan
- PX-150 196 Judge N. Littell, KNJ6056, Martinsville, Ind.  
 197 Y. Tanaka, JA32520, Nishinomiya Hyogo, Japan  
 198 Al Gulley, KIE0628, Caropolis, Pa.
- PX-175 167 Judge N. Littell, KNJ6056, Martinsville, Ind.  
 168 V. Cavicchi, KKD7623, Maristown, N.J.  
 169 D. Theison, KNN0810, Norwalk, Ohio  
 170 B. Stroud, KJI1090, Corning, N.J.  
 171 Al Gulley, KIE0628, Caropolis, Pa.  
 172 L. Lowell, KCD6109, Sellersville, Pa.
- PX-200 141 F. Mertz, KID0007, Hustontown, Pa.  
 142 G. Velpel, KHA8376, Garrett, Ind.  
 143 Al Gulley, KIE0628, Caropolis, Pa.  
 144 C. Marx, KLF1859, St. Paul Park, Minn.  
 145 L. Lowell, KCD6109, Sellersville, Pa.  
 146 D. Stoneburg, KGI7912, Omaha, Neb.
- PX-225 126 Hoatin Annie, KKA3340, Poquonnock Br., Conn.
- PX-250 176 V. Gould, KLP7641, Binghamton, N.Y.  
 177 W. Heimsath, KFD4886, Los Altos Hills, Calif.  
 178 E. Johnson, KLN9155, Manistee, Mich.
- PX-300 109 Edward Litke, KMD5165, New Windsor, N.Y.
- PX-350 105 Chuck Sylvester, KLK5617, Chicago, Ill.
- PX-375 102 Chuck Sylvester, KLK5617, Chicago, Ill.
- PX-400 103 Chuck Sylvester, KLK5617, Chicago, Ill.  
 104 Edward Litke, KMD5165, New Windsor, N.Y.
- PX-500 102 Ed. Litke, KMD5165, New Windsor, N.Y.  
 103 Barney Ross, KCG1087, Washington, D.C.
- PX-600 102 Ed. Litke, KMD5165, New Windsor, N.Y.
- PX-650 101 Stanley Penc, KJI3337, Utica, N.Y.



MSA 191 J. Pfau, KLL0517, Chicago, Ill.  
 192 G. Wiles, KKB4015, Williamstown, Mass.  
 193 Hootin Annie, KKA3340, Poquonnock Br., Conn.  
 194 Y. Tanaka, JA32520, Nishinomiya Hyogo, Japan  
 195 Dwight Delaney, KLK7493, Menomonee Falls, Wis.

SSC-1 206 R. Painter, KLM8694, Wyoming, Mich.  
 207 Y. Tanaka, JA32520, Nishinomiya Hyogo, Japan

SSC-2 160 Ray McMahon, KLV0247, Washington, D.C.  
 161 W. Heimsoth, KFD4886, Los Altos Hills, Calif.

SSC-3 133 Vern Gould, KLP7641, Binghamton, N.Y.

SSC-5 114 Chuck Sylvester, KKL5617, Chicago, Ill.

SSC-16 105 Barney Ross, KCG1087, Washington, D.C.

If you would like to be listed as a QSL card swapper in our monthly listing, you must do the following: send us a separate card for each month you would like to be listed (you may send several month's worth of cards at the same time), and enclose 10¢ in cash (no stamps, checks, or money orders) for each month you are to be listed. Try not to write on your cards and don't Scotch Tape your dime to the card. Address the material to: Card Swappers Unlimited, 14 Vanderventer Avenue, Port Washington, N. Y. 11050. Deadline for listing in the December issue is October 12th. Any cards received after this date will be listed in the following issue.

Here are this month's swappers:

1Q4271 Henry Sowa, P.O. Box 571, Holyoke, Mass.  
 1W6216 Errol Engraving, 36 Hampden St., Westfield, Mass.  
 2Q0152 Karl Weiss, 245 Ashmore Ave., Trenton, N.J.  
 2Q1147 George Delaney, 308-47th St., Union City, N.J.  
 2Q6980 Red Morgan, 144 Wilson Ave., Kearny, N.J.  
 3Q2103 Dorothy Teague, Box 99, Wrightstown, N.J.  
 485372 Jim Cross, 755 South Potomac St., Hagerstown, Md.  
 5Q2178 Elwyn Beam, Route 2, Vale, N. C.  
 6W7263 Bill Orton, 905 Altamaha St., Chattanooga, Tenn.  
 11Q1313 Desert Rat! 1171 W. Miracle Mile, Tucson, Ariz.  
 11Q2714 Eileen Inns, 530 Catalina Dr., Newport Beach, Calif.  
 11W9751 G. Strainline, 1171 W. Miracle Mile, Tucson, Ariz.  
 18B2648 Glenn Davis, 6143 North Rockwell St., Chicago, Ill.  
 18Q0790 Bill Miller, 407 Allison Rd., Middletown, Ky.  
 18Q3779 L. A. Morrow, 2210 N. Gayman Ave., Davenport, Iowa  
 18Q4913 Tom Leadbetter, R. R. 4 - Box 40, Muncie, Ind.  
 18Q6800 Dick Markle, Box 75 -- 11210 Arcola Rd., Arcola, Ind.  
 19A8145 Gene Hecht, 26 Sheridan, Pontiac, Mich.  
 19Q0707 Jim White, Box 108, Syracuse, Ohio  
 19Q8152 John Kasten, 5916 Westbrook Dr., Brookpark, Ohio  
 19Q9470 Adrian Fallert, 121 N. "C" St., Hamilton, Ohio  
 19Q9941 Martin Ripper, 7617 Cavell, Garden City, Mich.  
 20Q1360 Ivan Smith, 419 Water St., Danville, Pa.  
 20Q4195 Marv Vriklar, 148 Winthrop Rd., Syracuse, N. Y.  
 KAG1649 Al. Young, 350 Van Winkle Ave., Hawthorne, N.J.  
 KAG2486 Dave Buda, 717 Centre St., Nutley, N.J.  
 KAJ0765 J. L. Kirkland, Route 7, Raleigh, N.C.  
 KAR0738 The Card Swapper, P.O. Box 411, Westfield, Mass.  
 KBA5557 Ted Cummings, Bellflower Lane, Billerica, Mass.  
 KBA7154 Rodney Nelson, Hideaway Rd., Norwalk, Conn.  
 KBC4768 George Sherman, 25 Church St., Rutland, Vt.  
 KBC6229 Paul Conant, 139 North Main St., Florence, Mass.  
 KBC6415 Donald Aspinall, 20 Forest Ave., North Haven, Conn.  
 KBC6510 Ralph Bryant, 716 Riverside Dr., Fairfield, Conn.  
 KBC9193 John Weigel, 119 Shaw St., New London, Conn.  
 KBC9285 John Christofaro, 7 New Lane Rd., New Canaan, Conn.  
 KBD0747 Herb Girard, 348 Carrington Ave., Woonsocket, R. I.  
 KBD1849 Paul Sanders, 5 Victor Rd., Framingham, Mass.  
 KBC6576 Charles Armwine, 725 South Broad St., Trenton, N.J.  
 KGC7687 Robert Thatcher, R. R. 1 - Box 59-B2, Hudson, N.Y.  
 KBC8079 Alvin Allen, 610 Prospect Ave., Spring Lake Hts., N.J.  
 KBH0853 Tom Walton, 324 Kenilworth Rd., Louisville, Ky.  
 KBH1426 Fred Stearman, R. R. 1 - Box 16, Erie, Ill.  
 KBH0854 George Raybin, 1367 Sheridan Ave., Bronx, N.Y.  
 KBI1349 Jack Hopp, 240-19 144 Ave., Rosedale, N. Y.

KBI2123 Richard Rios, 2897 Ardsley Rd., Wantage, N.Y.  
 KBI2251 Mona French, 19 Essex Lane, Old Bridge, N.J.  
 KBI2504 Mike Troy, 271 North Ridge St., Port Chester, N.Y.  
 KBI4141 Danny Seifert, 163 So. Main St., Phillipsburg, N.J.  
 KBI4513 Al Leslie, 184 Wales Ave., River Edge, N.J.  
 KBI5592 George Gross, Waring Rd. M. D. #15, Newburgh, N.Y.  
 KBI6025 Max Latterman, Box 608, Rd. #1, Princeton, N.J.  
 KBJ6373 Charles Bennett, 89 Valley Rd., Haworth, N.J.  
 KBJ6480 Art Scheid, 2 Essex Place, Hartsdale, N.Y.  
 KBI7301/1 Bob Mihlon, 163 Thomas St., Bloomfield, N.J.  
 KBI8077 John Krejc, 60 Division Ave., Garfield, N.J.  
 KBJ0499 Herbert Kuehke, 10 E. Grand Ave., Montvale, N.J.  
 KBJ1722 George Hunt, 353 Highland Ave., Middletown, N.Y.  
 KBJ2055 Harmon Heller, 610 East 20th St., New York, N.Y.  
 KCC1541 Donald Berle, 228 California Rd., Quakertown, Pa.  
 KCC4177 Telstar, Don, 513 E. Market St., Pottsville, Pa.  
 KCC4461 Warren Greenspan, 1144 Oliver Rd., Huntingdon Valley, Pa.  
 KCD1896 Howard Taylor, South DuPont Rd., Penns Grove, N.J.  
 KCD3484 Telstar, Pat, 513 East Market St., Pottsville, Pa.  
 KCD5000 Bill Kocher, 702 Cambridge Ave., Bethlehem, Pa.  
 KCD5165 John Shronk, Box M, Mont Clare, Pa.  
 KCD5491 Bernie & Phyllis, 1509 Bondridge Rd., Wilm, Del.  
 KCD6109 Lois Lowell, R. D. 2, Sellersville, Pa.  
 KCD6125 Neil O'Connell, 22 Cassatt Ave., Berwyn, Penna.  
 KCF2541 James Lofton, 712 N. Loudoun St., Winchester, Va.  
 KCG0346 Bailey Curtis, 1028 Harrison Ave., Elkins, W. Va.  
 KCG2216 Doris Cross, 755 South Potomac St., Hagerstown, Md.  
 KCG2419 Park Bedford, 4903 Asbury Lane, Bethesda, Md.  
 KCG2891 Edith Becker, 5606 Franconia Rd., Alexandria, Va.  
 KCG3236 Bob Gallery, 5013 Westport Rd., Chevy Chase, Md.  
 KCG3068 Ricky Lowman, 1001 W. Addition St., Martinsburg, W. Va.  
 KCG3575 Jim Lot, White Post, Va.  
 KCG4106 Dave Royer, Route 1 - Box 133, Finksburg, Md.  
 KCI2842 Clarence Moore, Route 4 - Box 34, Thomasville, N.C.  
 KCI5991 Hillery Twine, 2815 Norfolk Rd., Suffolk, Va.  
 KCJ2292 Hazel Stubbs, P.O. Box 1076, Rockingham, N.C.  
 KCJ3880 Lee Willick, 3709 Hester Circle, Raleigh, N.C.  
 KCJ4079 Jack Kirby, 3601 North Ave., Richmond, Va.  
 KCJ4187 Joel Smyre, 747 S. Brady Ave., Newton, N.C.  
 KCJ5002 J. L. Kirkland, Route 7, Raleigh, N.C.  
 KCJ5092 Doug Paynter, 1001 East Jefferson St., Charlottesville, Va.  
 KCJ6987 Tommy Pollok, Gladys, Virginia  
 KCJ7737 Allon Clarke, 1009 Hamilton Ave., Clifton Forge, Va.  
 KCJ8516 The Morrisson's, 826 Longview Drive, Woodbridge, Va.  
 KCJ9615 James Surratts, Rt. 2 - Box 86, Denton, N.C.  
 KDB0371 Bill Howell, 545 Palmetto Lane, S.W., Aiken, S.C.  
 KDB9372 Claude Hooper, RFD 3, Box 130, Sylva, N.C.  
 KDC0443 John Blankenship, P.O. Box 363, Grayson, Ky.  
 KDC0614 Clarence Hnanicek, 10809 Prince Ave., Cleveland, Ohio  
 KDC0843 Raymond Sheely, Box 95, Petersburg, Ohio  
 KDC1255 Ben Hefner, 1804 Lennox Ave., Lima, Ohio  
 KDC1388 W. L. McKeever, 408 Lynn Ave., Lakeside, Ohio  
 KDC2091 Charlie Kreuger, Rt. 2, Marion, Ohio  
 KDD2134 Michael Ashby, 316 S. Franklin St., Tullahoma, Tenn.  
 KDE3230 George Payne, 17 Orton Drive, Maryville, Tenn.  
 KDI3558 Tom Smith, P.O. Box 147, Orlando, Fla.  
 KDJ0332 Nick Miller, Box 3006, St. Petersburg, Fla.  
 KEB1659 Ed. Field, P.O. Box 481, Gautier, Miss.  
 KEB1661 Bob Fancher, Darling, Miss.  
 KEB4002 Al Mayer, 306 West 8th, North Little Rock, Ark.  
 KEE2743 Harry Hoffpowner, 724 Coolidge Rd., Channelview, Tex.  
 KEE3288 Bill Long, 1110 Rouse, Houston, Texas  
 KEJ0071 Melvin Nutting, 932 Western Ave., Colton, Calif.  
 KEJ1341 E. H. Rogers, 24950 E. 6th St., San Bernardino, Calif.  
 KEJ5828 John Hamner, 12350 So. Fern Ave., Ontario, Calif.  
 KEJ5869 Johnnie France, Box 4146, Riverside, Calif.  
 KEJ6681 Bob Osterhout, 3624 Meier St., Los Angeles, Calif.  
 KPA2338 Frank Whetzel, 916 Larker Ave., Los Angeles, Calif.  
 KFA6387 George Prock, 4814 W. 131st St., Hawthorne, Calif.  
 KFA9923 Helen Morse, P.O. Box 1395, Ontario, Calif.  
 KFB0396 Ron Federico, 815 No. Palisade Dr., Santa Maria, Calif.  
 KFB0588 Don Zumwalt, Apt. 51, 5325 Sanger, Alexandria, Va.  
 KFD2822 Leon Bagdad, 844 W. Dayton, Fresno, Calif.  
 KFD4351 Steve Kruff, 1755 29th Ave., San Francisco, Calif.  
 KFD5345 Cecil Long, P.O. Box 367, Ivanhoe, Calif.  
 KFD5811 Larry Kluedner, P.O. Box 183, Oroville, Calif.  
 KFE0284 Julius Greenberg, 1326-32 Ninth St., Modesto, Calif.  
 KGC2295 Duane Foss, Box 238, Laramie, Wyoming  
 KGC2576 Gene Gosdoe, 1406 Onaida St., Denver, Colo.  
 KGF1675 Earl Wertz, 79 Kincheloe St., Kincheloe AFB, Mich.  
 KGH2584 Joseph Rose, 1009 Jfig, Wichita, Kansas  
 KGH3372 Wayne Hutchins, P.O. Box 311, Carthage, Mo.  
 KGI1077 Bob Fellows, Box 38, Goff, Kansas

KG16100 Robert Schmink, 357 No. Waco, Wichita, Kansas  
 KG16979 Don Marshall, 301 Circle Dr., Carrollton, Mo.  
 KG17912 Donn Stoneburg, Box 221 Ames Ave., Omaha, Neb.  
 KG18903 Ralph Williams, 3420 Nickell Dr., St. Joseph, Mo.  
 KG19206 Bud Ward, 968 Lindeman, Des Peres, Mo.  
 KHA0733 Harold Handley, 13800 W. 145th Place, Lockport, Ill.  
 KHA3908 Michael Hencz, 6080 N. Elston Ave., Chicago, Ill  
 KHA5150 Virg Mansfield, 600 West 7th, Muncie, Ind.  
 KHB1210 Gordon Velpel, 801 S. Franklin St., Garrett, Ind.  
 KHB1213 Larry Rost, R.R. #2, Muscatine, Iowa  
 KHB2113 Risley Farms, R.R. 4, Highway 15 W., Mt. Carmel, Ill.  
 KHB3556 John Ernstberger, 3516 S. Hermitage Ave., Chicago, Ill.  
 KHB3971 Larry Parkhurst, 1000 W. 11th St., Muncie, Ind.  
 KHC4185 Lou Chappell, 3644 E. Minnie St., Decatur, Ill.  
 KHC4453 Dick Stout, Maple Spring Farm, Chatham, Ill.  
 KHC7324 Puff The Hobo, 4424 Leesburg Rd., Ft. Wayne, Ind.  
 KHC9507 Bill Feece, P.O. Box 35, Donaldson, Ind.  
 KHD1288 Charles Couchman, Box 194, North Vernon, Ind.  
 KHD2732 Nick Schmidt, 1719 W. Catalpa, Chicago, Ill.  
 KHD3773 Lee Hunt, 1152 Bigger St., Gary, Ind.  
 KHD4705 George Newberry, 1027 W. Douglas St., Freeport, Ill.  
 KHD5777 Jim Carey, R.R. 1, Sylvan Lake, Rome City, Ind.  
 KHE0968 Mick Newton, 634 Madison Ave., Evansville, Ind.  
 KHG3085 Edwin Chisholm, 1825 Avon St., Saginaw, Mich.  
 KHG4945 C.M. Cooley, 1006 Hooven Ave., Hamilton, Ohio  
 KHG5776 Larry Hensley, 15 N. Dewey Rd., Amherst, Ohio  
 KHG5896 Ron Neufeld, 3090 E. Derbyshire, Cleveland Hts., Ohio  
 KHG5905 Bill Clouse, 569 Carey St., Zanesville, Ohio  
 KHG6176 Herman Werfele, 3121 Jacob St., Wheeling, W. Va.  
 KHG9031 Jack Pye, 1014 S. Campbell, Royal Oak, Mich.  
 KHG9085 Alfred Hogan, 1108 Walker St., Mansfield, Ohio  
 KHH2828 Frank Hall, 711 Water St., Barbourville, W. Va.  
 KHH3134 Flint McCullough, 800 12th St. S.W., Massillon, Ohio  
 KHI4973 John Campbell, 216C FTD - Box 201, Dow AFB, Bangor, Me.  
 KHI5457 Jeo. Barker, 343 N. 27th St., Battle Creek, Mich.  
 KHI9959 Gene Taylor, 121 N. Adolph Ave., Akron, Ohio  
 KHJ1206 Marty Snyder, 1516 Lockwood Rd., Barberton, Ohio  
 KHJ3477 Donald Beltz, 13474 Enid Blvd., Lake Fenton, Mich.  
 KHJ3482 Robert Albright, R. 3, Alpena, Mich.  
 KHJ3914 Ralph Jester, 564 Round Lake Dr., Mich. Center, Mich.  
 KHJ4747 Don Senger, 2650 Mandale, Orchard Lake, Mich.  
 KHJ5042 Harold Davis, 9575 Shell Beach Rd., Pinckney, Mich.  
 KHJ7033 Max Green, 100 North Main St., North Baltimore, Ohio  
 KHJ7131 Ken Massie, 115 Woodlawn Dr., Ironton, Ohio  
 KHJ7270 Bob Wilkinson, 500 Magnolia Ave., Cuyahoga Falls, Ohio  
 KHJ7892 Boots Beaudry, Box 252, Trenton, Mich.  
 KHJ7895 Bob Best, 12067 Greenlawn, Detroit, Mich.  
 KHJ8472 Doug Thrasher, 1164 Lindsay Ave., Akron, Ohio  
 KHJ9411 Jim Waters, 28 S. Pembroke Ave., So. Zanesville, Ohio  
 KHJ9558 Ed Leonhardt, 3518 Smithfield Lane, Cincinnati, Ohio  
 KIA0762 Leroy Butler, 1808 Lennox, Lima, Ohio  
 KIA0468 Clarence Kernstock, 1820 Filmore Place, Essexville, Mich.  
 KIC1207 Arlene Warner, 2273 Mosser Ave., Williamsport, Pa.  
 KIC2281 Mike Ripiski, 72 Mooney Rd., Plymouth, Pa.  
 KIC3500 Ruthie Bopp, 350 W. Fifth St., Lewistown, Penna.  
 KIC5642 Dave Klimeck, 218 Ottawa St., Johnstown, Pa.  
 KID0007 Fred Martz, Davis-Lane Speedway, Hustontown, Pa.  
 KID0186 Mike Reshetar, 102 1/2 Walnut St., Binghamton, N.Y.  
 KID3872 Herman Heuser, 341 West 11 Ave., Tarentum, Pa.  
 KID5223 Harry Platt, R.D. 1 - Shaw Rd., Conklin, N.Y.  
 KID5295 George Gould, P.O. Box 42, Hudson Falls, N.Y.  
 KID6356 Roscoe Harrington, 5 Schuyler St., Hudson Falls, N.Y.  
 KID7260 Stan Breitkopf, 271 Stanton Lane, Rochester, N.Y.  
 KID8232 Roy McGregor, R.D. 2, Central Square, N.Y.  
 KID9899 Ronald Hoover, 303 Eden Ave., Waynesboro, Pa.  
 KIE0628 Al Gulley, R.D. 3 - Box 392, Coraopolis, Pa.  
 KJ02223 J.C. McCalla, 273-G Dyea Ave., Ft. Richardson, Alaska  
 KJH0032 Jere Caricofe, 2301 Norfolk St., Hopewell, Va.  
 KJH0080 Robert Grubbs, Route 3, Winston-Salem, N.C.  
 KJ11924 Mike Gross, 1129 Victoria Ave., New Kensington, Pa.  
 KJ2293 The Silver Eagle, 339 Harter St., Herkimer, N.Y.  
 KJ2342 Fenton's, 125 A-W Lake Rd., Penn Yan, N.Y.  
 KJ2824 Oscar Lee, Box 605, Westfield, Pa.  
 KJ3461 John Garzel, Box 286, Austin, Pa.  
 KKA0658 Jerry Cote, 105 Old Walpole Rd., Keene, N.H.  
 KKA0880 Don Benoit, Lambs Grove, Spencer, Mass.  
 KKA1997 Jim McSwain, RFD 2, Windsor, Vt.  
 KKA3088 John Myott, 16 Washington St., Westfield, Mass.  
 KKA3340 Hootin Annie, 11 Forthill Rd., Poquonnock Br., Conn.  
 KKA4210 Dick Clogston, Stars, Maine  
 KKA4441 Sperm Irishes, West Peru, Maine  
 KKA5174 George Brown, 101 Truman St., New London, Conn.  
 KKA5305 Chase's Engraving, 175 Kitemaug Rd., Uncasville, Conn.

KKA5308 John Mildner, Roberts St. Rd. 1, Pascoag, R.I.  
 KKA6048 Mike Suintava, 198 Mercier Ave., Bristol, Conn.  
 KKA7064 Irving Norman, 9 Greenfield St., Pawtucket, R.I.  
 KKA7269 Phil Newcomb, 59 Center St., Ballardvale, Mass.  
 KKA7386 Tom Lambert, 295 Parkway Ave., Bangor, Maine  
 KKA7402 John Flynt, Royal Coach Hotel, Weirs Beach, N.H.  
 KKA7756 Armand Gladu, 2 Pinnacle Point, Adams, Mass.  
 KKA8101 John Moriarty, 86 Beacon St., Florence, Mass.  
 KKA8441 Leonard Prue, 11 Forthill Rd., Poquonnock Bridge, Conn.  
 KKA9690 Peter Flynn, 212 Allen St., Springfield, Mass.  
 KKA9926 Brian Benkosky, 343 Washington St., Keene, N.H.  
 KKB0087 James Lacey, 46 Oread St., Worcester, Mass.  
 KKB0156 Kevin Gobeille, 15 Wilson St., W. Wabraham, Mass.  
 KKB0242 Paul Ferland, 32 Arland Dr., Pawtucket, R.I.  
 KKB0399 Stan Holland, South Rumford, Rumford, Maine  
 KKB0549 LeGeYt Service, Hazard Ave., Thompsonville, Conn.  
 KKB0748 Tom Pluta, 31 Stony Hill Rd., Indian Orchard, Mass.  
 KKB1337 George Randall, 71 Taylor St., Granby, Mass.  
 KKB1587 Al Lapointe, 60 Prospect St., New Britain, Conn.  
 KKB2242 P.J.J. Crockodilos, 42 Devens St., Indian Orchard, Mass.  
 KKB3080 Elsie Randall, 71 Taylor St., Granby, Mass.  
 KKB3387 Tom Wilmarth, 466 Main St., Cromwell, Conn.  
 KKB3485 Russell Ferland, 32 Arland Dr., Pawtucket, R.I.  
 KKB3548 John Monaco, 118 Ledgcrest Ave., New Britain, Conn.  
 KKB3586 Ralph Gauthier, 227 Walnut St., Manchester, N.H.  
 KKB3611 Percy Coombs, 1 Sunset Terrace, Springfield, Vt.  
 KKB3702 Ron Corda, 525 Nichols Ave., Stratford, Conn.  
 KKB3740 Donald Cone, RFD 1 - Box 54, White River Jct., Vt.  
 KKB3757 Harrison Cunningham, 71 Water St., Hallowell, Maine  
 KKB4033 Roland Brown, RFD 1, Durham Rd., Dover, N.H.  
 KKB4058 Phil Gomez, Lebanon, N.H.  
 KKB4081 Mike Moise, 200 N. Main St., S. H Falls, Mass.  
 KKD0349 Jack Golden, 5025 Broadway, New York City, N.Y.  
 KKD0491 Mike Kaplan, 37 Fairview Terrace, Maplewood, N.J.  
 KKD1177 Christopher Ordal, 5 Shelley Rd., Short Hills, N.J.  
 KKD1640 Al Stanley, 1056 President St., Brooklyn, N.Y.  
 KKD1699 Lou Gangeini, 12 Shelley Ave., Hartsdale, N.Y.  
 KKD1746 Ivan Samuels, 179 Glenview Rd., South Orange, N.J.  
 KKD1946 Al Neely, 90-26 215 Place, Queens Village, N.Y.  
 KKD2292 Henry Meyer, 50 Knickerbocker Rd., Plainville, N.Y.  
 KKD2495 Jay Dubner, 1072 Ruth Place, North Bellmore, N.Y.  
 KKD4696 Ed. Ruthger, 26 Jackson Ave., Middletown, N.Y.  
 KKD6953 Peter Mozzone, 382 Horton Hwy., Mineola, L.I., N.Y.  
 KKD7499 Norman Bernstein, 90 Redwood Lane, Massapequa Pk. N.Y.  
 KKD7623 Vinny Cavicchi, Lake Valley Rd., Morristown, N.J.  
 KKD7750 Joel Fishman, 1810 - 80th St., Brooklyn, N.Y.  
 KKD7950 Joseph Krzanik, Box 171, New Baltimore, N.Y.  
 KKD7992 Robert Bernsen, 85 Cupsaw Dr., Ringwood, N.J.  
 KKD8361 Theresa, Wally, Theresa, 210 Correja Ave., Iselin, N.J.  
 KKD8372 Mike Mazzone, 438 Livingston Ave., Albany, N.Y.  
 KKD8383 Bob Peterson, 61 Crosshill Ave., Yonkers, N.Y.  
 KKD8680 John Meyer, 50 Knickerbocker Rd., Plainville, N.Y.  
 KKD8859 Charles McNally, 36 Marble Hill Ave., New York, N.Y.  
 KKD9486 Willie Bergman, 248-02 76th Ave., Bellerose, L.I., N.Y.  
 KKD9510 Ray Dame, 38 Vliet St., Cohoes, N.Y.  
 KKD9511 Mitch Zimmer, 1213 E. 83rd St., Brooklyn, N.Y.  
 KKD9849 Mike Guerrieri, Hill St., Mahopac, N.Y.  
 KKE0171 Al Siebold, 110 Jefferson Ave., River Edge, N.J.  
 KKE0449 Al Farber, 2554 E. 29th St., Brooklyn, N.Y.  
 KKE0563 Steve Selbach, 129 Gordon Ct., Oradell, N.J.  
 KKE0684 Brian Zeky, Box 131, Craryville, N.Y.  
 KKG0371 Ken Yost, Sunser Lake Rd., Newark, RD. 1, Del.  
 KKG0960 Robert Ream, 608 High St., Lancaster, Pa.  
 KKG1280 Clarence Diehl, 800 Mohican St., Bethlehem, Pa.  
 KKG3229 Don Schmitt, Box 14, Gettysburg, Pa.  
 KKG3987 John LeMay, 28 E. Water St., Gettysburg, Pa.  
 KKG4032 Sophia Mitch, 309 South St. Cloud St., Allentown, Pa.  
 KKG4281 Charles Lucabagh, 916 Baltimore St., Hanover, Pa.  
 KKG4482 Lee Petrucchi, 316 West Van Buren Ave., New Castle, Del.  
 KKI12063 Jack Mory, 2501 Washington Blvd., Balto., Md.  
 KKI12915 George Bowen, 831 W. Matthews Ave., Baltimore, Md.  
 KKI12997 Don Breitweiser, 947 Maryland Ave., Hagerstown, Md.  
 KKI3040 Kay Bowen, 831 W. Matthews Ave., Baltimore, Md.  
 KKI3302 David Shor, 2518 Summerson Rd., Baltimore, Md.  
 KKI3355 Donald Vaughn, 318 Mulhenny St., Woodstock, Va.  
 KKI3800 Steven Cockrell, 228 Church St., Clarksburg, W. Va.  
 KKI3995 Ray Clift, 122 East 3rd St., Frederick, Md.  
 KKI4574 William Haines, P.O. Box 333, Riverdale, Md.  
 KKK0471 J.L. Kirkland, Route 7, Raleigh, N.C.  
 KKK0745 Jim Chocklett, 504 Denby St., Wilson, N.C.  
 KKK0927 Tommy Gay, 1146 Rodgers St., Chesapeake, Va.  
 KKK1145 Jim Brizendine, 2016 Wayne St. N.E., Roanoke, Va.  
 KKK2366 Jack Barbour, 1659 Old Buckroe Rd., Hampton, Va.

KKK2869 Kelly Howard, 415 Broad St., Oxford, N.C.  
 KKK4410 Smylie Grantham, P.O. Box 364, Raeford, N.C.  
 KKK4489 Tommy Spain, 1927 N. Junaluska Dr., Richmond, Va.  
 KKK4512 Jake Sprouse, Rt. 6 - Box 279, Charlottesville, Va.  
 KKK6182 Gordon Gallahan, 211 Butler Rd., Fredericksburg, Va.  
 KKK6388 Bill Ball, Box 65, Raven, Va.  
 KKK7191 Herman Cone, 1811 Dalton Rd., Greensboro, N.C.  
 KKK7550 Black Jack, P.O. Box 261, Colonial Heights, Va.  
 KKM0193 Daniel Parker, Armathwaite, Tenn.  
 KKM1253 Buford Richey, 225 Davis Ave., Florence, Ala.  
 KKM2052 Linton Slappay, P.O. Box 52, Plains, Ga.  
 KKM2213 Lee Harvey, 2478 Sharrondale Dr. N.E., Atlanta, Ga.  
 KKM4690 Roy Chaffin, 505 First Ave., Mt. Pleasant, Tenn.  
 KKM6607 Neal Alexander, 3790 Wieuca Terrace, Atlanta, Ga.  
 KKM7376 Donald Wilson, 1529 Bush Blvd., Birmingham, Ala.  
 KKM7482 Charles Cromer, Route 1 - Box 282A, Newberry, S.C.  
 KKM7788 Claude Witt, 814 S. Webb Ave., Crossville, Tenn.  
 KKM8888 Leon Rhodes, Box 11 Piedmont Rd., Rutherfordton, N.C.  
 KKM9702 James Wolfe, 1707 Merrycrest Dr., Memphis, Tenn.  
 KKN0224 Jerry Bumbaugh, 316 Crest Dr., Boone, N.C.  
 KKN0258 Bill Powers, P.O. Box 104, Bowling Green, S.C.  
 KKN0300 Steve Masten, P.O. Box 4, Boone, N.C.  
 KKN0673 Randall Thomas, Box 108, Boone, N.C.  
 KKN0762 Jud Kessler, 63 Main St., Garden City, Ga.  
 KKN0793 G.W. Page, Box 398, Lake View, S.C.  
 KKN1566 Joseph Fail, Troy State College, Troy, Ala.  
 KKN2631 Warren Stevens, 770 Longleaf Dr. N.E., Atlanta, Ga.  
 KKN2690 Carroll Rogers, Box 178, Middletown, Conn.  
 KKN2985 Charles Martin, Rt. 6 Harrison Pk., Cleveland, Tenn.  
 KKN3229 T.J. Gibson, Box 564, Bennettsville, S.C.  
 KKN4052 Harvey Massie, Route 3 - Box 95A, Sylva, N.C.  
 KKP1645 Henry McLeod, P.O. Box 126, Perry, Fla.  
 KKP2232 John Sanders, 3209 Cherokee Ave., Tampa, Fla.  
 KKP2242 Frank Wolfgang, 4729 Bay Vista Ave., Tampa, Fla.  
 KKP4124 Gene Paigrin, 5111 68th St. North, St. Petersburg, Fla.  
 KKP4260 Clark Dickinson, Rt. 2 - Box 50, Perry, Fla.  
 KKR3709 W.D. Arnold, Beulah, Mississippi  
 KKR5223 Charles Keathley, 3005 Loma Dr., Little Rock, Ark.  
 KKR6231 Mike Anderson, P.O. Box 2626, Laurel, Miss.  
 KKT3680 Le Winder, 4204 Oaklawn St., Bryan, Texas  
 KKT3774 Bill Freeman, 4000 Nagle, Bryan, Texas  
 KKT4113 James Bowman, Box 703, Fresno, Texas  
 KKV0974 John Polhemus, 6855 Arboreal Dr., Dallas, Texas  
 KKV4589 Paul Drennon, 2402 Anderson, Irving, Texas  
 KKV5488 Joe Schrader, Box 464, Ponca City, Okla.  
 KKV5575 Alan Haile, 2601 Walnut St., Texarkana, Texas  
 KXX1831 Joe Stechnij, 555 W. Mahoney Ave., Mesa, Ariz.  
 KXX2834 Desert Rat's Wife, 1171 W. Miracle Mile, Tucson, Ariz.  
 KXX5201 Dale Fletcher, 54728 El Prado Trail, Yucca Valley, Calif.  
 KXX7505 Pete Gabel, 4240 Palmero Dr., Los Angeles, Calif.  
 KXX7642 Walter Koziel, P.O. Box 2212, Bell Gardens, Calif.  
 KXX7809 Joe Ilions, 12929 Warren Ave., Mar Vista, Calif.  
 KLA2524 John Brown, P.O. Box 502, San Pablo, Calif.  
 KLA2619 Stan France, 2651 Dorset, Napa, Calif.  
 KLA3291 Paul Linehan, 2 Estabueno Dr., Orinda, Calif.  
 KLA3573 Stephen Ward, 1756 Hallmark Ln, San Jose, Calif.  
 KLA4568 Jeff Morgensen, 31 Estabueno, Orinda, Calif.  
 KLA5065 Dennis Simonson, 127 Lee Ave., San Francisco, Calif.  
 KLA5187 Ken Anderson, P.O. Box 1008, Los Gatos, Calif.  
 KLA5788 Tom & Elaine Saunders, 782 Hutchings Dr., San Leandro, Cal.  
 KLA6569 Bob Wright, 1243 Sierra Mar Dr., San Jose, Calif.  
 KLA7292 Wayne Metzger, 4068 N. 3rd, Fresno, Calif.  
 KLA7428 Jack Evans, P.O. Box 108, Ivanhoe, Calif.  
 KLD0511 Tex Warner, 506 Edith St., Walla Walla, Wash.  
 KLD0953 Keith Howe, 9001 - 16th Avenue S.W., Seattle, Wash.  
 KLD1817 Don Fletcher, 3432 So. 180 Pl., Seattle, Wash.  
 KLD2362 Richard Spengler, Rt. 1 - Box 48, Grangeville, Idaho  
 KLE0268 Tom Raczkyowski, Rt. 1 - Box 77, Laramie, Wyo.  
 KLE2219 Art Paulk, 3262 W. 3800 So., Salt Lake City, Utah  
 KLF2980 Steve Butler, 822 North Glendale Ave., Tomah, Wis.  
 KLH3541 Jim Walker, 2803 Lewis St., Biloxi, Miss.  
 KLH6909 Larry Kobberman, Box 233, Remsen, Iowa  
 KLH8133 Norman Royal, Syracuse, Nebraska  
 KLI1335 Phil Holcomb, 712 Dubuque St., Sioux City, Iowa  
 KLI1365 Glenn Earney, 928 Olympia Dr., Ferguson, Mo.  
 KLI1434 W.H. Stalons, 3903 Garfield, Lincoln, Nebr.  
 KLJ0255 Bob Pierce, 182nd St. - Box 382, Lansing, Ill.  
 KLJ0280 Al Warshaw, 1905 E - 86th St., Chicago, Ill.  
 KLJ1650 Dan Wright, 1336 Blaine Ave., Janesville, Wis.  
 KLJ2946 Harold Bjorkquist, 8878 South 84th St., Franklin, Wis.  
 KLJ3945 William Turner, 1728 Ford Ave., Owensboro, Ky.  
 KLJ4142 Jon Kramer, R.1, Box 45J, 606 Highland Dr., Trevor, Wis.  
 KLJ5764 Gene Stewart, 1310 N. Berkley, Urbana, Ill.  
 KLJ6057 Myrtle Hittle, 1601 So. 4th St., Richm ind, Ind.  
 KLJ6167 Ron Kman, 7848 So. Austin, Oaklawn, Ill.  
 KLJ6791 Lou Rubenstein, 9901 Calhoun Ave., Chicago, Ill.  
 KLJ8259 Jack Jackson, Morocco, Indiana  
 KLI408 Leon Adams, 509 May St., Sumner, Ill.  
 KLI1581 Frank Hawley, 2313 Johnson St., Keokuk, Iowa  
 KLI1975 W.H. Willeit, Lewisport, Ky.  
 KLI2328 John Wigginton, R.R. #1, Lincoln, Ill.  
 KLI2458 Lincoln Ide, 7842 So. McVicker, Oak Lawn, Ill.  
 KLI2730 Ken, 905 W. Indiana Ave., South Bend, Ind.  
 KLI2881 Buzz Colburn, 902 Oak Lane, Russellville, Ky.  
 KLI3619 Matt Loeffler, 2169 South 64th St., West Allis, Wis.  
 KLI4264 Jim Nall, 606 North Hite, Louisville, Ky.  
 KLI4317 Pat Cavanaugh, 3620 West Southland Dr., Franklin, Wis.  
 KLI4537 Clinton Whitney, R.R. 2, Warsaw, Ind.  
 KLI4830 Francis Wagner, Elizabethtown, Indiana  
 KLI4886 Charlotte Stearman P.O. Box 326 Albany, Ill.  
 KLI4958 Jesse Wade, 224 W. Elm St., Chillicothe, Ill.  
 KLI5617 Chuck Sylvester, 1629 East 86th Place, Chicago, Ill.  
 KLI5810 Irving Felzer, 2131 So. 15th Place, Milwaukee, Wis.  
 KLI5824 Eric Seymour, 408 W. 32nd St., Connorsville, Ind.  
 KLI6006 Bob Hertzberg, 5213 W. Parkview Dr., Mequon, Wis.  
 KLI9539 Mike Geiger, Box 83, Culver, Ind.  
 KLL0681 Dick Strichter, 851 E. Pleasant St., Freeport, Ill.  
 KLL0800 Gil Davis, 2405 Sunset Blvd., Anderson, Ind.  
 KLL0809 Fritz Stearman, Albany, Ill.  
 KLL0995 Jim Mazurek, 1444 S. Clinton Ave., Berwyn, Ill.  
 KLL1090 Reid Kenley, P.O. Box 427, Maywood, Ill.  
 KLL1097 Kenneth Fruit, R.R. 2, Huntington, Ind.  
 KLM0542 Merle Lane, 1610 Royce Ave., Kalamazoo, Mich.  
 KLM1447 Lee Collins, 4814 Sundale, Drayton Plains, Mich.  
 KLM3314 Paul Monhart, 2170 W. 63 St., Cleveland, Ohio  
 KLM4219 Eddie Welch, 177 Broadway Ave., Masury, Ohio  
 KLM4343 Mike Meyer, 134 Reif St., Frankentum, Mich.  
 KLM4519 N.J. Schwitzer, P.O. Box 232, Defiance, Ohio  
 KLM4842 Bessie Hazen, 231 North Mead St., Zanesville, Ohio  
 KLM5051 Jim Swart, 62 Stadium Dr., Tallmadge, Ohio  
 KLM7160 Harold Theiss, 6103 Dibble Ave., Cleveland, Ohio  
 KLM7450 Bill Piper, RFD #5 - Box 414, Swanton, Ohio  
 KLM7506 Frank Bradd, P.O. Box 336, Marshall, Mo.  
 KLM7513 Bruce Muthup, 5109 Pensacola Blvd., Dayton, Ohio  
 KLM7763 Jim Warner, 836 Pensacola, Pontiac, Mich.  
 KLM7788 Charles Holland, 942 Lingle Ave., Owsosso, Mich.  
 KLN0934 Leonard Beaudry, 32821 River Rd., E. Rockwood, Mich.  
 KLN1014 Tim Taylor, 4908 Swetland Blvd., Richmond Hts, Ohio  
 KLN1732 Art Lucas, 1011 W. Cherry Creek Rd., Mio, Mich.  
 KLN2229 Jerry Bradley, 1881 Whitefeather Rd., Pinconning, Mich.  
 KLN2610 Joe Tyka, 1410 Maple St., West Belaire, Ohio  
 KLN3263 Henry Smith, 11944 Algonquin, Pinckney, Mich.  
 KLN3497 Ed Newton, 2120 Irving Dr., Benton Harbor, Mich.  
 KLN3731 Norm Sieggreen, 1532 N. Bond, Saginaw, Mich.  
 KLN4091 Clare Wilson, 94 E. Colgate, Pontiac, Mich.  
 KLN5264 V.A. Norling, 25 Indian Trail, Poland, Ohio  
 KLN5598 Rawlings Funeral Home, London, Kentucky  
 KLN5726 Douglas Dix, 3307 Martindale Rd. NE., Canton, Ohio  
 KLN6383 Robert Saltsman, 412 Water St., Salineville, Ohio  
 KLN8016 Don Gold, 116 Stewart Ave., Sidney, Ohio  
 KLN8105 Gabby Rodabaugh, 10078 E. Coldwater, Davison, Mich.  
 KLN8233 Don Gorda, 1854 Warwick, Lincoln Park, Mich.  
 KLN8383 Phil Samuelli, 3503 Orchard, Portsmouth, Ohio  
 KLN9155 Evans Johnson, 115 McKeek, Manistee, Mich.  
 KLN9345 Jim Stephens, 132 Lawnview Ave., Springfield, Ohio  
 KLN9710 Ray Keller, 852 N. Rosedale Ave., Lima, Ohio  
 KLO0175 Paul Manville, 1736 Lombardy, East Highland, Mich.  
 KLO0253 Marvin Davis, W. Wayne St., Dunkirk, Ohio  
 KLO0366 Pete Snyder, 4321-10th Ave., Parkersburg, W. Va.  
 KLO0519 Don Jones, R.R. #2, Lawrenceburg, Ky.  
 KLO0598 William Lechner, 4441 Parnell, Pontiac, Mich.  
 KLO0638 Dick Seperic, 3324 Karen St., Lansing, Mich.  
 KLO1270 Bob McClellan, Box 51, 203 Furnace Ave., Elberta, Mich.  
 KLO1619 Bruce Macbeth, 5631 Sandalwood Ave. NE., N.Canton, O.  
 KLO2529 James Jones, 523 West Main St., Zeeland, Mich.  
 KLP0269 George Stradtman, 410 E. 8th St., Bloomsburg, Pa.  
 KLP0319 Pete Hons, 614 Main St., Portage, Pa.  
 KLP2238 James Barner, Rt. 3, Gorton Rd., Corning, N.Y.  
 KLP3284 James Phillips, 599 West 8th St., West Wyoming, Pa.  
 KLP3877 Jean Hoover, 303 Eden Ave., Waynesboro, Pa.  
 KLP3765 Ken Clemens, Box 71, Yorkville, N.Y.  
 KLP3877 Jean Hoover, 303 Eden Ave., Waynesboro, Pa.  
 KLP5005 Bud Fowkes, 1031 5th Ave., Duncansville, Pa.  
 KLP5525 Bill Beeke, 11 Maple Dr., Bath, N.Y.  
 KLP6039 William McKenna, 1354 Davis St., Elmira, N.Y.



KLP6626 Wallace Nolen, 12 Chase St., White Plains, N.Y.  
KLP6639 Don Berman, 121 W. Ross St., Wilkes Barre, Pa.  
KLP7086 William Baun, 5 Second St., Dolgeville, N.Y.  
KLP7184 T. Ken Davis, 118 Strang St., Westfield, N.Y.  
KLP7516 Guy Widmeyer, Box 99-A, Hopwood, Pa.  
KLP7578 David Moss, P.O. Box 61, Endicott, N.Y.  
KLP7749 Ray Brander, 146 9th St., Monessen, Pa.  
KLP7848 Bryan May, 417 Old River Rd., Wilkes-Barre, Pa.  
KLP7879 Clarence Peet, Box 73, Port Crane, N.Y.  
KLP8083 Howard Davidson, 26 Knight St., Glens Falls, N.Y.  
KLP8791 Jim Smith, R.D. 3, Fort Plain, N.Y.  
KLP8809 Don Shumaker, 147 Greenbrier Dr., Carnegie, Pa.  
KLP9151 Bob Lance, 10 Fredella Ave., Glens Falls, N.Y.  
KLP9534 Steve Delorm, 258 Spencer Rd., Rochester, N.Y.  
KLP9557 George Booth, 971 Sweeney St., No. Tonawanda, N.Y.  
KLP9618 Bill Lohnes, Box 176, Round Lake, N.Y.  
KLP9789 Ed Kindervater, Box 404, Hopwood, Pa.  
KLQ0114 Roger Hamm, 1447 Union Center, Endicott, N.Y.  
KLQ0457 Charles Goughnour, 207 Coldren St., Johnstown, Pa.  
KLQ0660 Jerry Monroe, R.D. 1, Coy Road, Greenfield Center, N.Y.  
KLQ0964 Pete Guy, Box 55, Middle Grove, N.Y.  
KLQ1059 William Nagurney, 727 Marion St., Scranton, Penna.  
KLQ1173 Lester Finnegan, 8171 Main St., Williamsville, N.Y.  
KLQ1560 Jud Kurlancheek, 242 East Dorrance St., Kingston, Pa.  
KLQ2180 Jim Mitnik, 1500 Oliver Ave., Conemaugh, Pa.  
KLQ2217 Don Anderson, 528 Ridge Ave., Cannonsburg, Pa.  
KLQ2274 Carl Jaegers, R.D. 2, Sunbury, Pa.  
KMA0060 Norman Harold, 27 Blantyre Rd., Malden, Mass.  
KMA0173 Joe Witek, 40 Daniel St., Indian Orchard, Mass.  
KMA0517 Earl Holbrook, 29 Maynard St., Attleboro, Mass.  
KMA1395 Ray Martel, 143 Parker St., New Bedford, Mass.  
KMA2028 Edwin Keller, 10 South St., Plymouth, Mass.  
KMA2125 Anthony Viera, 9 Holway Ave., Provincetown, Mass.  
KMA2378 E.L. Bradshaw, 114 Walter St., Bangor, Maine  
KMA2531 Mike Palmieri, 1 Brigham St., Waterville, Maine  
KMA2585 Walter Palasz, 56 Ames Ave., Chlocepe, Mass.  
KMA2766 Chuck Saverse, High Manor Park, Rockville, Conn.  
KMA3004 Al Pelc, 117 Pilmonth St., Southbridge, Mass.  
KMA3375 Paul Connors, 31 New Winchendon Rd., Baldwinville, Mass.  
KMA3425 Edmond Brenesh, 4282 Main St., Stratford, Conn.  
KMA3941 Chris Marinelli, 45 Milton St., New Britain, Conn.  
KMA3939 Johnny McGann, 50 Coombs St., Southbridge, Mass.  
KMA4164 John MacDonalds, Warren, New Hampshire  
KMA4703 David Menoche, 15 Polo St., Pawtucket, R.I.  
KMA5273 James Stuart, 45 South Main St., Baldwinville, Mass.  
KMA5715 George Goodell, Enfield, N.H.  
KMA5726 Eddie Bellar, 15 Rockland St., Fitchburg, Mass.  
KMA5788 Gary Supsinskas, 331 Stanley St., New Britain, Conn.  
KMA5931 Jeff Biden, Carthage, Maine  
KMA6506 Otis Butler, Cedar Haven Motor Court, Brewer, Maine  
KMA7167 Edward Madej, 193 Oak St., Indian Orchard, Mass.  
KMD0190 Andy D'Arco, E. 252 Homestead Rd., Paramus, N.J.  
KMD0428 David Bellask, 1159 E. 42 St., Brooklyn, N.Y.  
KMD0490 Fred Decter, 339 Leslie St., Newark, N.J.  
KMD0980 Rick Cary, 565 Edmund Terrace, Paramus, N.J.  
KMD0992 Howard Huncke, 518 Mountain Ave., Springfield, N.J.  
KMD1113 Richard Harvey, 133 Morris Ave., Summit, N.J.  
KMD1314 John Humphries, 102 Lincoln Ave., East Paterson, N.J.  
KMD1704 Rich Feinberg, 53 Washington Ave., E. Paterson, N.J.  
KMD1813 Paul Lustig, 23 Dobbs Terrace, Scarsdale, N.Y.  
KMD2018 Ron Kerber, 25 Broadway, Park Ridge, N.J.  
KMD2130 Chuck Austin, 10 Excelsior Ave., Troy, N.Y.  
KMD2334 Sherwood Wile, 15 Vanderventer, Pt. Washington, N.Y.  
KMD2476 Gene Rosenberg, 367 Grant Ave., Oradell, N.J.  
KMD3059 Bruce McPherson, 231 Wales Ave., River Edge, N.J.  
KMD3327 W. Mitchell, 31 Fowler Ave., Newburgh, N.Y.  
KMD3719 Dale Schmalings, 239 Seymour Rd., Port Chester, N.Y.  
KMD4005 John Wilmot, P.O. Box 515, Montclair, N.J.  
KMD4398 Lawrence Cohen, 1254 East 86th St., Brooklyn, N.Y.  
KMG0063 Jeff Keiser, R.D. 1, Annville, Pa.  
KMG0214 Rich Matiza, 1437 Reservoir Ave., Roslyn, Pa.  
KMG0471 Charlie Stauffer, R.D. 1, Holtwood, Pa.  
KMG0515 Michael DeRossi, So. East Ave., Vineland, N.J.  
KMG0524 Gary Nicholson, 801 North Pitt St., Carlisle, Pa.  
KMG1344 Dorian Stuart, 613 Carsonia Ave., Pennside, Reading, Pa.  
KMG1460 John Whorrell, Fleetwood, R-2, Pa.  
KMG1618 Jtm Storrrell, Central Ave., Bargaintown, N.J.  
KMG1726 John Wilhelm, 401 2nd, Holloway Terr., New Castle, Del.  
KMG1866 Don Titus, R.D. 1, Gettysburg, Pa.  
KMG1872 Bill Westcott, 819 North 25th St., Reading, Pa.  
KMG1918 The Reinhardts, 445 Independence Dr., Burlington, N.J.  
KMG2513 Harry Watson, 53 W. Columbia Ave., Lindenwood, N.J.  
KMG2638 George Sayers, 317 W. VanBuren Ave., New Castle, Del.

KMI0163 George Demanelis, 200 Wilson Ave., Morgantown, W. Va.  
KMI0928 Jim Shaffer, 109 South Front St., Georgetown, Del.  
KMI0962 Wm. McDowell, 8 Jones St., Piedmont, W. Va.  
KMI1219 Russel Lopez, 216 Elk Ave., Nutter Fort, W. Va.  
KMI1934 Joe Myers, 99 Liberty St., Westminster, Md.  
KMI1946 Bob Anderson, 10323 Crestmoor Dr., Silver Spring, Md.  
KMI1975 Bill Rowan, 718 S. 51st St., Baltimore, Md.  
KMI2262 Todd Smith, 828 Hamilton Blvd., Hagerstown, Md.  
KMK0600 R.C. Shanks, P.O. Box 252, Montross, Va.  
KMK0678 Edith Grantham, P.O. Box 364, Raeford, N.C.  
KMK1360 Lee Estes, 1717 Galloway Dr., Charlottesville, Va.  
KMK2054 Jim Scott, Gladys, Va.  
KMK2560 Julian Thomas, 1408 Florence Rd., Charlottesville, Va.  
KMK3175 Bill Lane, 302 Myrtle Lane, Altavista, Va.  
KMM0243 Mike Murphy, 4505 Rogers Rd., Chattanooga, Tenn.  
KMM0474 Albert Phillips, 892 Breedlove St., Memphis, Tenn.  
KMM0591 Robert Dean, 301 N. Cherokee Ave., Dothan, Ala.  
KMM1135 Lonnie Jenkins, 8 Ranger Dr., Charleston Hts, S.C.  
KMM1177 Ted Booth, 231 Illinois St., Travis AFB., Calif.  
KMM1484 Jerry Morgan, 106 Merchant St., Mt. Pleasant, Tenn.  
KMM1812 Jimmy Allen, 909 Prospect Ave., Newport, Tenn.  
KMM2386 Linda Chaffin, 505 First Ave., Mt. Pleasant, Tenn.  
KMO0404 Lawrence Fried, 3070 Seaview Lane, Bellmore, N.Y.  
KMP0707 Jimmy Roberts, 2304 Palmdale St., Jacksonville, Fla.  
KMP0848 Jim Skidmore, Rt. 2 - Box 281, Palatka, Fla.  
KMP2491 Carroll Pirtle, 2213 Barry Dr., Fort Myers, Fla.  
KMR1149 Linda Loftin, Rt. 1 - Box 429, Deridder, La.  
KMR1383 John Funk, Route 4, Paragood, Ark.  
KMR1859 Kenneth Gunter, 2781 N. Thompson Dr., Mobile, Ala.  
KMR3460 Elmo Valesga, 445 Day Dr., Baker, La.  
KMR4011 Michel Fourrier, 3650 Hundred Oaks, Baton Rouge, La.  
KMR4249 Bruce Broyles, P.O. Box 161, Newport, Ark.  
KMT1506 Vernelle Cates, 1310 North Dakota, Baytown, Texas  
KMT1963 Tommy Winder, 307 Hensel, Bryan, Texas  
KMX0073 Jim Stewart, 9335 Carmel Rd., Atascadero, Calif.  
KMX0339 Hal Manheim, 12907 Warren Ave., Los Angeles, Calif.  
KMX2815 C.A. Emerson, 7448 E. Holly, Scottsdale, Ariz.  
KMX3234 Ron Murphy, 12993 Herrick St., Sylmar, Calif.  
KNA1724 John Byrnes, 140-31st Ave., San Mateo, Calif.  
KNA2637 Denver Landis, P.O. Box 655, Cupertino, Calif.  
KNA3418 George Bray, 2187 Meadowglen Ave., Sacramento, Calif.  
KND0168 Barry Simpson, 4819 So Fife, Tacoma, Wash.  
KNF1478 Bob'n Lullung, 7 No. Broadway Apt. 2, Watertown, So. Dak  
KNF1721 M.L. Gibson, Rt. 1 - Box 22-H, Mountain Iron, Minn.  
KNF2116 Ralph Jacobsen, Rt. 4 - Box 58, Waupaca, Wis.  
KNH0542 Larry Huggins, 614 N. Chestnut St., Olathe, Kans.  
KNH0786 Bill Howard, 2700 Grandview Ave., Des Moines, Iowa  
KNH2593 Lou Hartmann, 125 E. Holden, Lemay, Mo.  
KNH3016 Lee Glorie, 101 Fannie, Lemay, Mo.  
KNH3499 Dillard Smith, 1610 Nall St., Sherman, Texas  
KNH3738 Red Shaw, 9010 Sycamore, Kansas City, Mo.  
KNH4790 Don Drey, 12186 Parkwood Pl., Bridgeton, Mo.  
KNH6376 Bill Hayes, 902 No. Colorado, Wichita, Kansas  
KNH6618 John Berends, 2208 Empress Dr., St. Louis, Mo.  
KNJ0959 Bill Berendts, Kalona, Iowa  
KNJ1286 John Stiglich, 1101 Cora St., Joliet, Ill.  
KNJ1289 Richard Morgan, Box 891, Supply Sq., Duluth, Minn.  
KNJ2128 Jim Siddons, 604 20th Ave. Ct., East Moline, Ill.  
KNJ3086 Janet Stanley, 334 N. Franklin St., Dunkirk, Ind.  
KNJ3100 Steve Sallac, R.R. 4 - Box 10, Valparaiso, Ind.  
KNJ3143 Emmett Rount, Wyandot, Ill.  
KNJ4342 Kenn Paulini, 2243 Birch St., Des Plaines, Ill.  
KNJ4360 Andy Croxton, 4241 Main St., Downers Grove, Ill.  
KNJ4430 David Conder, 1319 South Cherry, Centralia, Ill.  
KNJ4735 Arthur Martin, 424 E. 4th St., Mishawaka, Ind.  
KNJ5625 Dave Ludwig, 1325 Lincoln Way, East Mishawaka, Ind.  
KNJ6056 Judge Littell, R. 6, Lake Edgewood, Martinsville, Ind.  
KNJ6149 Stewart Witkov, 9110 N. LaCrosse, Skokie, Ill.  
KNJ7169 Robert Euerick, R.R. 2 - Box 20-B, Noblesville, Ind.  
KNJ7476 Chuck Niebauer, 174 East Cleveland Rd., So. Bend, Ind.  
KNJ7802 Wm. Wallace, 35 Gilbert St., Savanna, Ill.  
KNJ8625 Charlie Tuegel, 2318 Prince, Dubuque, Iowa  
KNJ9435 Fred Hammerich, 267 Eleventh St., La Salle, Ill.  
KNJ9805 Mark Fumagalli, 931 Highland Ave., Joliet, Ill.  
KNK0240 Don Field, 464 Shabbona Dr., Park Forest, Ill.  
KNK0256 Dennis Cornell, 10 W. Dover Dr., Des Plaines, Ill.  
KNK0561 Gordon Gerber, 688 Chester Ave., Elgin, Ill.  
KNK1126 Richard Danhauer, R.R. 2, Leitchfield, Ky.  
KNM0810 Don Theisen, 53 Norwood Ave., Norwalk, Ohio  
KNM1285 Mark Berger, 3000 Dale Ave., Columbus, Ohio  
KNM1533 Glen Wright, Rt. 1 - Box 122A-1, Hurricane, W. Va.  
KNM2171 Gary Maturen, 1003 Court, Saginaw, Mich.  
KNM2845 Marion Rizer, Box 19, Mason, W. Va.



KNM2986 Jeff Chern, 7404 Devon Lane, Chesterland, Ohio  
 KNM3050 Jim Dameron, 2556 N. Union Rd., Dayton, Ohio  
 KNM3839 Skye Wittig, 603 Spruce St., Manistee, Mich.  
 KNM4570 Myrtille West, 1804 East Ganson St., Jackson, Mich.  
 KNM4813 Jim Waters, 28 S. Pembroke Ave., South Zanesville, Ohio  
 KNM5016 Bill Brooks, 117 W. Stewart Ave., Flint, Mich.  
 KNM6195 Larry Reed, Box 2075, Williamson, W. Va.  
 KNM6202 Clarence Wzresinski, 207 St. Mary's Pkwy, Vanistee, Mich.  
 KNM6687 Joe Kazanic, 635 Derring, Akron, Ohio  
 KNM6782 Elwood, Duty, Route 1, Central Station, W. Va.  
 KNM7922 Raymond Patton, 222 Kontner St., Nelsonville, Ohio  
 KNM7532 Wilbur Meadows, 212 Sanderson St., Pontiac, Mich.  
 KNM8026 Mel Kropko, 465 Manderley, Akron, Ohio  
 KNM8674 Larry Richardson, 536 Miami Ave., Barberton, Ohio  
 KNM9486 Stephen Hodges, 105 1/2 5th St., Ludington, Mich.  
 KNM9699 Ted Davis, R. D. 1 - Box 38-A, Farmdale, Ohio  
 KNN0426 Bob Mebs, 935 Islington, Toledo, Ohio  
 KNN0420 Leonard Szalony, 8118 Portage Rd., Kalamazoo, Mich.  
 KNP0020 John McCutcheon, R. D. 2, Westfield, Pa.  
 KNP0036 Tom Braddock, 518 Green St., Freeland, Pa.  
 KNP0126 Earl Sprague, Port Henry, N. Y.  
 KNP0224 Dave Latina, 458 Harvest Dr., Rochester, N. Y.  
 KNP0457 Jeff Ohlsson, 86 Bowen St., Jamestown, N. Y.  
 KNP0567 Bob Ivanoff, 726 Ellsworth Ave., Jeannette, Pa.  
 KNPI042 Don Lewis, 33 South Morningside Dr., Binghamton, N. Y.  
 KNPI200 Chuck Kratochvils, 111 Cort St., Jeannette, Pa.  
 KNPI421 John Ricci, 2835 Fourth Ave., Beaver Falls, Pa.  
 KNPI444 Paul Clark, 863 Monaca Rd., Monaca, Pa.  
 KNPI445 Earl Roehl, 861 Monaca Rd., Monaca, Pa.  
 KNPI508 William Seward, Lansing Rd., Hagaman, N. Y.  
 KNP2225 Robert Madison, 1515 Edgar Ave., Chambersburg, Pa.  
 KNP2429 Bob Bialecki, 17 Roser St., Rochester, N. Y.  
 KNP2464 Otto Elderkin, Deer Creek Rd., Portville, N. Y.  
 KNP2471 Jim Laubs, Route #1, St. Thomas, Penna.  
 KNP2730 Dick Newell, 395 Fairmount, Jamestown, N. Y.  
 KNP4176 Ron Taylor, Chapel Hill Rd., East Randolph, N. Y.  
 KNP4353 Chuck Harrison, 140 Whitehill Ave., Jamestown, N. Y.  
 KNP4524 David Disbrow, 32 Hollister St., Dundee, N. Y.  
 KNP5155 John Thompson, 436 N. Main St., Wilkes Barre, Pa.  
 KNP5446 Carl Valerio, 203 South Duane Ave., Endicott, N. Y.

KNP5523 Lloyd Doxey, 807 Elizabeth St., Mechanicville, N. Y.  
 KNP5743 Gene Wingert, 8 Lincoln Ave., Waynesboro, Pa.  
 KNU0024 James Schubauer, 420 Haines, Fairbanks, Alaska  
 KNU0079 Dale Martin, 516 N. Pine St., Anchorage, Alaska  
 KNV0070 Bill Parker, 1023 - 16th St. N.E., Washington, D.C.  
 XM112045 Lloyd Tait, 132 Riverside Dr., Penticton, B.C.  
 XM23597 Byron Orge, P.O. Box 1122, Medicine Hat, Alberta, Can.  
 XM41747 Capt. Blood, R. R. 1, Orillia, Ont., Canada  
 XM412800 Skippy Massam, 66 Guthrie Ave., Toronto, Ont., Canada  
 XM43614 Jacob Fehrman, R. R. 1, Port Colborne, Ont., Canada  
 XM431259 Denis Dubois, Box 71, Welland, Ontario, Canada  
 XM441325 Daugherty Electronic Service, Box 272, St. Thomas, Ont.  
 XM442411 Bill Kerwin, 287 Nelson St., Sarnia, Ontario  
 XM522895 Bernard Rachlin, 2615 Kent Ave., Montreal, Que., Canada  
 XM53463 Francois Goyer, 259 rue Moisan, Drummondville, P. Q.  
 XM567012 Francoise Bourassa, 1012, Notre-Dame, Shawinigan, Quebec  
 Cent. 3250 David Sigo, Rt. 1 - Box 153, Goodland, Ind.  
 North3020 Robert Ream, 608 High St., Lancaster, Pa.  
 North3300 Tom Bolling, 233 Temple St., Fredonia, N. Y.  
 WPE1CRM Alan Michalek, 227 Redlands St., Springfield, Mass.  
 WPE1GCM Terry Henry, 55 S. Lincoln St., Keene, N. H.  
 WPE1GDZ Win Quayle, 7 Doncaster Rd., Lynnfield, Mass.  
 WPE1GHU Noel Vander, 63 East Clinton St., New Bedford, Mass.  
 WPE2ICH Walter Haines, Sandtown Rd., Medford, N. J.  
 WPE2NHW Gerry Schechter, 3535 Kings College Pl., Bronx, N. Y.  
 WPE2NIO Sheldon Shuff, 105-57 Flatlands 8th St., Brooklyn, N. Y.  
 WPE3FQQ Donald Schmitt, Box 14, Gettysburg, Pa.  
 WPE3FSC Robert Ream, 608 High St., Lancaster, Pa.  
 WPE4ENC Jimmy Bullock, 1628 Long Ave., Nashville, Tenn.  
 WPE6GBC Henry Slade, 136 Tamarack St., Vandenberg AFB, Calif.  
 WPE8HLZ Doug McAbee, P. O. Box 205, Goodrich, Mich.  
 WB6PGN Jeff Mosby, 433 1/2 Leland Ave., San Jose, Calif.  
 TRQ1000 David Bubeck, 109 E. Main St., Schuylkill Haven, Pa.  
 OZDR1261 Palle Nielsen, Humlebaekgade 13", Copenhagen N, Denmark  
 ONL170 Jacquet Camille, UBA P. O. Box 634, Brussels, Belgium  
 Ralph Bryant, 716 Riverside Dr., Fairfield, Conn.  
 Ruth Charon, 109 Bowers St., Holyoke, Mass.  
 Central Printing, 920 Vandeventer, Fayetteville, Ark.



# WHY SETTLE FOR LESS AT TWICE THE PRICE?

## Buy QSL's WHOLESALE!

Before you buy QSL cards from anyone... Write for  
**FREE 16 page CATALOG & SAMPLES. Top Quality,  
 Fast Delivery & Low Wholesale Prices.**

CBC WHOLESALE CLUB  
 Dept. S  
 Box 631  
 Lexington, N. C. 27292

Name \_\_\_\_\_  
 Address \_\_\_\_\_  
 City \_\_\_\_\_ State \_\_\_\_\_ Zip \_\_\_\_\_

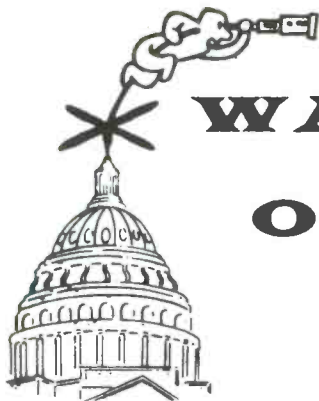

# WASHINGTON OUTLOOK

Judging from the amount of FCC activity in the following report, as compared with previous months, it looks as if the FCC has relented somewhat in their CB policing. Anyway, here's what happened to whom:

- Licenses revoked:

KLJ2298, William Styren, Chicago, Ill., for failing to respond to official communications.

KKK5050, Billy K. McIntyre, Asheboro, N. C., for failing to respond to official communications.

19QA0086, John C. Morrow, Kalamazoo, Mich., for failing to respond to official communications.

KDD9787, Lawrence W. Frazier, Nashville, Tenn., for failing to respond to official communications.

11Q0752, Costa Mesa Welding Supply, Costa Mesa, Calif., for failing to reply to official communications.

KBA8374, John T. Megas, Winter Harbor, Me., for repeated violations of rules by failing to reply to official communications, for the use of nonpermissible communications, for failure to limit communications with other stations with other radio stations to five consecutive minutes, failure to address communications to specific radio stations within the direct groundwave coverage of his station, and failure to identify station.

- The operators of the following stations were asked to show cause why their licenses should not be revoked:

KEE1886, Clint Leone, Nederland, Texas, for repeated violations of antenna height and maximum power limitations.

KAI3704, Emery J. Stanchin, Pleasure Ridge Park, Ky., for failing to reply to official communications requesting licensee to furnish certain information.

KFA2238, Betty Johnson, Compton, Calif., failing to reply to official communications.

KIC7185, John R. Benchoff, Blue Ridge Summit, Pa., for failing to reply to official communications.

KLP7387, R. B. Nelson Co., Rochester, N. Y.,

for failing to reply to official communications.

KHI5408, John J. Rowell, Lansing, Mich., for failing to reply to official communications.

KHD9016, Marjorie Wishner, Milwaukee, Wisc., for operating with power in excess of maximum authorized, in willful violation of rules against transmitting communications concerning obscene, indecent or profane language; for failing to maintain control of station.

KAL0118, Charles W. Carnes, Dansville, N. Y., for repeated violations of Section 1.89 of the rules and by failing to reply to official communications requesting licensee to furnish certain information.

- The following, unfortunately, received notices of a \$200 monetary forfeiture:

KMM3091, E. E. Parks, Birmingham, Ala., for repeated and willful violations of the rules regarding failure to identify station and the use of nonpermissible communications.

KLA4751, William F. Weber, Fresno, Calif., for repeated and willful violations of the rules by failing to identify station and use of nonpermissible communications.

- These operators were notified that they owed the government \$100 for rule violations:

KLI0304, Robert G. Sechrest, Birch Tree, Mo., for repeated and willful violations of rules regarding use of nonpermissible communications.

KKM8382, Billy Ben Bradshaw, Calera, Ala., for repeated and willful violations of rules by use of station for communicating over 150 miles.

- On a happier note, this CB'er had a \$200 monetary forfeiture reduced to \$100:

KKA8943, Grandville W. Davis, McKinley, Me.

- This CB'er was even fortunate enough to get the FCC to chop his \$200 down to only \$50: KKM7750, Wayne M. Graham, Atlanta, Ga.

- On another happy note, these operators had \$100 monetary forfeitures reduced to \$25:

KKA1432, Francis R. Copeland, Ellsworth Me.

KLP5586, B&L Furniture, Rochester, N. Y.  
KDI1946, John Hendry, Hialeah, Fla.

KBE0110, Elden Colbeth, Swans Island, Me.  
KKR5520, William G. Barnes, Saraland, Ala.

• These operators had FCC actions against them either dismissed or set aside:

KFA0767, Alice Mitchell, Ontario, Calif., show cause proceeding dismissed. Her license was cancelled.

KLA4482, Louie B. Standberry, Berkeley, Calif., show cause order set aside because licensee had responded to the FCC's communications prior to issuance of the show cause order.

KBA8604, Langlois Trucking, Cape Elizabeth, Me., show cause order dismissed because licensee has taken corrective measures to preclude a recurrence of the violations which brought on the original order.

KFA3127, Alpha Baker, Jr., South Gate, Calif., show cause order dismissed because licensee has settled his liability with a monetary forfeiture and has taken corrective measures to preclude a recurrence of the original violations.

KKA6690, Gerard V. Goodwin, Franklin, Me., show cause order dismissed—same reason as KFA3127.

• In other FCC actions involving CB'ers, the FCC:

Requested that William Ray Wilson, KCF-1516, of Glen Burnie, Md., notify them in writing whether he desires to appear at a formal hearing to present evidence with regard to the allegations of violations in his show cause order, or whether he elects to waive such hearing and submit a statement in explanation of the alleged violations.

Granted petition by Val-Eyre, Brownsville, Tex., for reconsideration of a March 26th order which revoked its license for station KEE3849. In granting the petition, it set aside the revocation order. Licensee has taken corrective measures to preclude a recurrence of the original violations.

Stayed license revocation of KLK7610, Floyd O. Whitcomb, Davenport, Iowa, until February 7, 1966, unless set aside or affirmed by subsequent order.

Denied request for reconsideration of revocation notice which was submitted by Arnell M. Thurman, ex-KKM2576, of College Park, Ga. It was determined that his present request did not set forth any relevant fact not previously considered.



## CHEAP SAM

*Continued from page 9*

aluminum paint to try and slow down weathering effects—but be careful not to get any of the paint on the plastic insulating material which is found on CB antennas.

If your coaxial cable is connected to the antenna by means of a PL-259 connector, snip off

the old connector and install a new one. If your cable is attached to screw terminals, then cut the cable down an inch or two and scrape new leads. Then, either wrap the connector with plastic electrical tape when it has been placed back on the antenna, or coat the leads to the antenna terminals with nail polish, shellac, or Krylon plastic spray.

While these measures may sound like a lot of bother to you, please believe me that they are a necessity. You will probably notice an immediate improvement in your communications from the antenna work alone—especially if your sky hook has been up (and unattended) for a year or two.

When working inside the set, remember that electricity can give you quite a severe sting. Unless it is absolutely necessary for the particular test you are doing, keep the set unplugged. If the set is on and you are working in its innards, keep one hand in your pocket to make certain that you don't accidentally ground yourself with fatal results. Respect electricity—when working with it use extreme caution.

Also, when you have a monumental problem with your equipment—or trouble in the frequency determining circuits, or final amplifier, it's best to leave the tinkering to a professional. We have attempted here to only offer some of the most basic first-aid advice for your trusty CB rig.



## CB 10-8!

*Continued from page 23*

where the control tower of the nearest airport is monitored. It's a simple matter to switch the antenna to any of the receivers, in the event it is desired to monitor distant stations.

With the squelch controls all set, it's a relatively simple matter to let all three sets perk along—they don't seem to cause any interference with each other (as many people had warned they would). Sometimes, when stations from all three bands are on at the same time, it gets a little noisy though. Result? Well, we have been able to get first hand information on a number of emergencies for our CB club—and I would say that we have been of some genuine assistance in several. Naturally, we have a liaison with the various departments involved and would not consider butting into their work without their consent and advice.

In case you are wondering, it is *not* against the law to monitor police frequencies (although some states have regulations against police receivers in cars). You can listen to *any* frequencies you want, so long as you do not divulge the contents of the transmissions without the permission of the persons transmitting the signals. Refer to Section 605 of the Communications Act

of 1934, as amended, for the complete facts on these laws.

Perhaps you aren't part of a CB club's emergency monitoring program—maybe you just get a fantastic kick out of eavesdropping on news in the making—in any event, you'll find interest in setting up a monitoring station such as the one described here. Read "What You Should Know About CB Monitoring," on page 9 of the April, 1965, S9, for some information on the various stations operating on these bands.



## POCKET-CEIVER

*Continued from page 30*

connections can be made by heating the wire and quickly pushing it through the plastic wall. The volume control-ON/OFF switch and phone jack are mounted on the box cover.

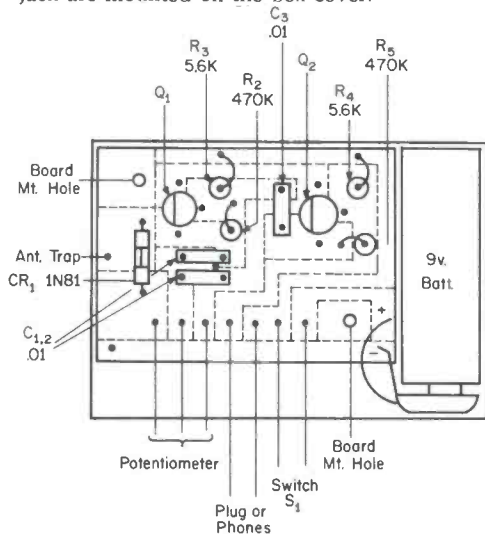

The printed circuit board can be mounted to the box with four No. 2-56 machine screws or cemented with an application of General Electric RTV-103 silicone rubber. To hold the battery securely in place, cement two pieces of foam rubber or plastic above and below the battery which will compress against the battery when the lid is closed. A miniature crystal earphone is used in the circuit shown. If a high impedance dynamic earphone is selected, remove resistor R4 (56K) from the circuit. Mount and connect all components as shown in the wiring diagram. If the printed circuit board used in this receiver is not in stock at your authorized G-E distributor, send one dollar to Don Steeb Inc., 955 Milstead Way, Rochester, N. Y., and he will send you the circuit board in return. Please specify board Number G.E.1 in your order.



## WALKIE-TALKIE

*Continued from page 21*

whop, whop," of the rescue helicopter.

The helicopter pilot had been talking with the A1 pilots and by then 10-27'd to the same frequency as Townsend's walkie-talkie.

"Do you see me?" Townsend asked the helicopter pilot as the aircraft passed over him. "I'm just up the hill from the parachute."

The helicopter came by again and this time spotted Townsend waving wildly with one hand and holding the walkie-talkie to his face with the other.

"The helo came in close and dropped the sling," Townsend said later. "We were off and climbing before I even got inside."

Debriefers later asked him if he had brought any of his survival gear back with him. "Only the radio," Townsend said.

The little walkie-talkie was much too "handy a piece of gear" to leave behind.



## KBG4303 RIDES AGAIN

*Continued from page 7*

The alternatives are to either have an article end after taking up only an inch or two of a page, or just to arbitrarily chop a few paragraphs out of an article to make it fit exactly into one, two, or three pages. These are both poor alternatives.

Using runback is something done by just about every publication (even newspapers) and I can't see why it upsets so many people when we do it at S9. In fact, without giving away too many secrets of my own personal reading habits, I just happen to have a September copy of *Playboy* at my desk—here is a story which starts on page 139, is continued on 152, then to 164, from 164 we skip to 194 for a straight run to page 200 where we are told to continue on page 207. Now, I realize that S9 doesn't present subject matter of anywhere near the same interest scope as *Playboy*, but at least we sell as many copies as *Playboy* in Clinton, Iowa (see September's *Reader Mail* in S9).

At any rate, we use runback because we have to without sacrificing editorial or graphic quality. Maybe when Hefner stops doing it in *Playboy*, we'll see his method and copy it.

## INTERNATIONAL HOAX

Among the many CB'ers we considered for inclusion in our recent "International CB Callbook," was a name which was submitted to us by many CB'ers throughout the U.S. and Canada. This "foreign" CB'er is apparently quite a swapper, judging from the number of people who told us about him. He's from Thailand, al-



though he has a temporary U.S. address in Ohio. His callsign is HSA-HSZ-08X.

Nobody caught on to the fact that the CB'ers name was Sudo Nimm (a "cute" spelling of *pseudonym*—a pen name), and that the cards were printed up as a hoax by a clever swapper residing at the Ohio address. The "HSA-HSZ" business was an attempt to improve Thai call letters, but the poor soul who made up the cards didn't know that Thai stations are assigned call-signs lying within the entire callsign block of HSA-HSZ. A typical Thai call would be something like HSD7, or (in the case of an Amateur station) HSIWR—but never anything like HSA-HSZ. That would be the same thing as an American with a call like WAA-WZZ or KAA-KZZ.

Anyway, please be advised that there is no such CB station with this call, there is no CB'er with the name of Sudo Nimm, there is probably no *Pagoda Clusters Boulevard* in Bangkok, and we do not count cards swapped with "HSA-HSZ-08X" towards any S9 Swappers Awards. 

## READER MAIL

*Continued from page 4*

ucts, as far as your readers are concerned, and has factual errors.

FCC type acceptance of a product assures your readers a well engineered and carefully produced article that meets the standards of good engineering practice. Shoddy merchandise just can't meet type acceptance requirements and the manufacturer either improves or goes out of business. The customer benefits by better and more reliable products in the long run.

Many of the same arguments against type acceptance that you set forth, were presented years ago, when type acceptance for the Marine Service and the Aviation Service were first proposed. If you would look into the history of these services, you would admit that technical advances were not slowed, but accelerated by type acceptance. Let us look at commercial two-way FM. Without strict standards of performance assured by type acceptance, split channel operation would not be possible today and the resultant increased occupancy usage of the frequencies would not be possible.

Frankly, I am personally amazed that you did not endorse and support our petition for the betterment of the Class D Citizen Service, which you admit is needed. What better method can you suggest? I see nothing constructive in your editorial to suggest a better way. Unless the Service is cleaned up, it will be lost entirely. If you doubt these words, read the Commission's statements.

We are certain that, even if we hadn't requested a rule change for type acceptance of Part 95 equipment, some other reputable individual group or company would have done so. You must know, of course, that a major trade association, several manufacturers and the Commission staff, have informally discussed the need for type acceptance for at least a year.

Your editorial probably did more to help our petition before the FCC for type acceptance of CB equipment than any other single event to-date. This editorial is astounding in its illogical, poorly thought-out, emotionally loaded and erroneous conclusions.

Our CB-3A is FCC type accepted, as was our CB-3, at \$149.95, which was certainly competitive at that time, and still is competitive. As you are well aware, we did not "sit back and rest on his oars." The net cost of type acceptance of the CB-3A to the consumer is less than one-half dollar! The FCC very clearly sets forth the specifica-

tions and tolerances permitted for type acceptance and has had these on the books since Part 19 went into effect some six years ago. The CB-3 was tested and evaluated by our Engineering Department and the results submitted to the FCC with the necessary documentation and certifications. If equipment is originally designed to FCC specs, there is little reason for "... back goes the rig to the Engineering Department (where, by the way, it never left!) for further design work, then more testing," or "... designing, re-designing, and re-re-designing."

May I further call your attention to another grievous error. Your analysis of the Hallicrafters CB-3A, 8 channel citizens band unit with the Hallicrafters BT-20 is completely untrue and you leave with the reader, an erroneous impression.

The Hallicrafters citizens band unit, Model CB-3A, is FCC type accepted, as well as the Hallicrafters BT-20. The difference in price of approximately \$200 rests in the fact that the CB-3A is a five-watt AM unit, while the BT-20 is a 20-watt FM unit.

For your information (and you might have gotten the facts by simply checking with me), the BT-20 has roughly a 2½ times greater Bill of Materials than the CB-3A. Therefore, your comparison is specious and ill-founded.

Being in the CB publishing field and a long-time radio communicator, you are well aware of the NORMAL life expectancy of most CB equipment. Five years is the usual figure used. Sure, there are many SX-28's in use today, quite a few transmitters, and receivers of an even earlier vintage than the '28, but with the constant advances in electronics, new products perform better.

The petition submitted to the FCC certainly was not intended, and cannot be construed, as a "cure-all" for the ills of CB. The operators of CB stations are people. In every group there are those who consider themselves accepted, or exempted, from the law. Is not the auto accident rate a testimonial to this? The petition only requests that the equipment licensed to individual or company, meet certain technical standards when manufactured.

The petition also requests prohibiting modifying the transmitter by non-technical people, to abrogate type acceptance. With the exception of the amateur radio service, the transmitters in all of the services must be type accepted. Your suggestion that CB is not as much of a "safety device" as the equipment in the land mobile business frequencies, is absurd. The thousands of members of REACT are certainly in a position to testify to the contrary.

But, again, at this point you entirely ignore the purpose of type acceptance, which is to provide the user with communication equipment which has been certified by the manufacturer to an agency of the United States Government, that the equipment complies with certain technical standards set forth by accepted professional engineering practice. How else can we make sure that equipment will make best use of the valuable radio spectrum, but to use every tool available, so that the emitted signals are clean and don't cause needless and harmful interference within the Service or to other services.

I would also like to remind you that TV and FM receivers now manufactured, require certification as to compliance on oscillator radiation, to guard against interference with other services.

It would appear that you could have rendered all CB'ers a service, as a responsible editor, to have published the petition and checked your editorial carefully for facts before you published it.

Very sincerely yours,

F. A. FRANKE, *Manager*  
New Products Development  
The Hallicrafters Co.

*When our editorial appeared in the August issue we spoke to the people at Hallicrafters and invited them to submit their comments for presentation to our readers.*

*Perhaps our readers would like to comment on the possibilities of type acceptance of CB equipment.* 

# PSSST!

## HEY BUDDY!

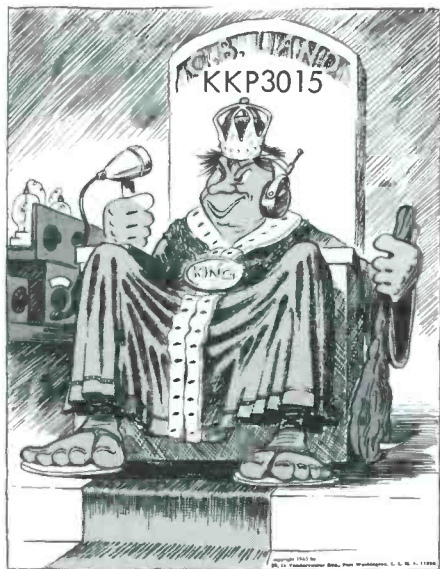

*Were you one of the many readers who wrote to us to ask if we could furnish reprints of our wildest of all S9 covers, the "King of The Band" one we had in February? Well, we can't.*

*BUT we did take this same illustration and enlarge it to a giant 8½" by 11" size, print it in three dazzling colors, and figure out how to personalize it with your call sign on the throne.*

*If this doesn't shake up visitors to your CB shack, nothing will. It looks dandy in a frame and makes a sneaky gift for someone who has everything. It comes postpaid, and personalized with your call (or any other call or name you specify) for only 50¢ in coins (no stamps or checks please).*

*Order this winner now from: King of The Band, S9 Magazine, 14 Vanderventer Avenue, Port Washington, N. Y. 11050.*

## CB SHOP

Rates for CB SHOP are 10¢ per word for advertising which, in our opinion, is obviously of a non-commercial nature. A charge of 25¢ per word is made to all commercial advertisers or business organizations. A 5% discount is in effect for an advance insertion order for six consecutive months.

We do not bill for advertising in CB SHOP. Full remittance must accompany all orders and orders sent in otherwise will not be run or acknowledged.

Closing date is the 15th of the 2nd month preceding date of publication.

We reserve the right to reject advertising which we feel is not suitable.

Because the advertisers and equipment contained in the CB SHOP have not been investigated, the publishers of S9 cannot vouch for the merchandise or services listed therein.

THE BAND BLASTER super Nuvistor microphone amplifier installs between your mic input jack and grid in less than 30 minutes. The poor man's way to be king of the mountain. Only \$9.95, wired and tested from Sentry Mfg. Co., P.O. Box 12322, Oklahoma City, Okla. 73112.

QSL's by Brownie "W3CJI." Since 1939—Quality CB-WPE-QSL cards. Samples 10¢ with catalog 25¢. 3111 Lehigh, Allentown, Pa.

QSL's, 8-12 different beautiful embossed glittering cards 25¢, refundable coupon. Andy's, Bridge St., Amsterdam, N. Y.

"ARE YOU SINCERE? Are you really looking for the best deal on a new or fully guaranteed used CB unit? Let us convince you with a specific quote that will really save you money. GRAHAM RADIO, Dept. E, Reading, Massachusetts."

CB DEALERS ONLY—One of the nation's largest suppliers of connectors, test equipment and accessory items has a new Catalog our listing direct-to-the-dealer prices on the items most needed by your customers. A card to LOGAN RADIO COMMUNICATION SUPPLY, 2110 Avenue J, LUBBOCK, TEXAS 19405, will bring your firm a copy.

HEY PUSSY CATS! Want a sneaky way to build up your card swappers collection? We will ship you 25 different cards for only \$1. No printers samples or junk, but REAL CB QSL's from all over, some actually signed by the ops. S. Nussbaum, 1440 50th St., Brooklyn, N. Y. 11219.

PLUG IN our shortwave converter and receive any single frequency (AM or FM) between 25 and 180 mc/s. Connects in seconds to any auto radio without tools, switches in or out of circuit. Fully wired and tested, transistorized, and with self-contained battery, you can use it to monitor CB, police, fire, telephone, aircraft, hams, taxi, business band, etc. When ordering, specify channel you wish to receive and also a clear frequency on your radio dial below 1000 kc/s. Only \$37.50, complete. From Sentry Mfg. Co., P.O. Box 12322, Oklahoma City, Okla. 73112.

When experience counts, it's S9 every time!

MINIATURE LICESE PLATE. Your CB, Ham, WPE or Part 15 call sign embossed in raised letters on 7" x 2 1/2" steel plate. \$1.00 postpaid. RGN, P.O. Box 145, Yale, Michigan 48097.

Heathkit owners, double reception! SK-3 Preselector fits GW-10, SW-11; SK-4 fits GW-12. \$8.99 kit, \$11.99 wired. Postpaid. Free kit, antenna list. HOLSTROM, Box 8640-S, Sacramento, California 95822.

Special PL-259 connectors 29¢ (10 lot) 40¢ single. Postage paid. Reduced prices on all radio parts, tubes, equipment. MIDWEST RADIO CO., 110 East Kansas, Smith Center, Kansas.

FREE CB QSL SAMPLES. From \$2.50 per 100. Radio Press, Box 24S, Pittstown, New Jersey.

CB Crystals—\$1.75 each postpaid. Any channel, any set. QUAKER ELECTRONICS, P.O. Box 215, Hunlock Creek, Pa.

CB DEALERS!! — If you haven't got it — you can't sell it. Why send your business somewhere else? Here at Graham Radio, we have thousands of CB and amateur radio units and accessories at dealer wholesale prices, and available for immediate shipping. Write for our latest dealer catalog. Graham Radio Inc., Dept. S, Reading, Mass. 01867. Tel. (617) 944-4000.

CB CHRISTMAS CARDS. Imprint and envelopes included 50 for \$2.00 postpaid. Fine quality send for details. Bob Cleary, Box 468, Binghamton, N. Y.

CONVERT your car radio to a super sensitive shortwave receiver with a Sentry Universal Converter. Will receive any band between 40 and 60 mc/s, convert it to the broadcast band. Wired and tested, less crystal only \$9.95. With crystal (specify band desired) only \$14.95. Sentry Mfg. Co., P.O. Box 12322, Oklahoma City, Okla. 73112.

QSL's—THE NEW LOOK—REASONABLE—Samples 10¢—VY's, QSL's, 1704A Hale, Fort Wayne, Indiana 46804.

"Audio-Aid-All" Clipper-Filter kit, \$10.99; \$14.99 wired. Boosts modulation, aids reception. SK-20 Preselector for SWL's, kit \$18.98. Postpaid. HOLSTROM, Box 8640-S, Sacramento, California 95822.

"QSL's. Top quality, reasonable price. Samples 20¢. CB Press, Box 281, Oak Park, Illinois 60303."

QSL Cards—Full Color, Glossy Stock. Free Samples. F. B. Mathews, 1616 Rural Street, Rockford, Illinois 61107.

"EARS" Increases your receiving distance to 5 to 40 miles. Smaller than a penny match box. Mounts internally in all CB transceivers. 50 per cent more squelch action, increases sensitivity 80 times, more gain than dual stack 5 element beam, adjustable gain control, comes with 10 inch long leads, 2 1/2 inch mounting bolts, mounts any position, wired and tested, ready to install. Instructions included. Specify type of CB unit and whether 6 or 12 volts. "Ears" by Carroll will make your receiver as good as money can buy. \$15.00 postpaid. Carroll Electronics, 3175 Barron, Memphis, Tennessee 38111.

S9 = more news, more authors, more value!

## CB IN ACTION

By Les Hench, KHA3272  
Sales Manager  
Pearce-Simpson, Inc.



Congratulations to Jon Lueck for another fine award winning example of how "CB in Action" saves lives. A Pearce-Simpson COMPANION II CB is on its way to help you at work and to provide further service to your family and the community.

"Dear Les:

"It was Saturday, January 23, 1965, about ten minutes past 5:00 P.M. It was dusk—about that time of the day when headlights are a must but don't aid much in driving. It had rained about three hours and now temperatures were dropping to below zero and it was snowing pretty hard. The roads were becoming slippery in spots but county crews had salted the road I was traveling and I had good traction.

"My gas truck had just been loaded at the bulk plant in Markesan with 850 gallons of gas and 400 gallons of fuel oil for a total of 1250 gallons of product and we were proceeding to go home to Kingston, 8 miles away. As we drove (I say "we" because I had two young boys with me, both age 12), we encountered an intersection two miles out of Markesan where we had the right-of-way. From my right, out of the blind corner, came a blurr and there was a terrible impact, and suddenly I didn't have control of my truck. It traveled out of control for 285 feet, left the road, passed through a shallow ditch, through a fence and into a plowed field. My lights were out, but because my CB radio was hooked direct to the battery its tubes burned brightly and had withstood the impact.

"Practically before the truck stopped, I found myself shouting for help over the radio. A reply was returned immediately from Rolland Ruenger from my home town of Kingston, 6 miles away. I reported that the two boys and I were OK (one of the boys was his son) and I told him to stand by while I checked the occupants of the other vehicle. In a few seconds I ran back down the road coming upon a demolished pick-up truck which had traveled into the ditch on the other side of the road. I pulled the door open and the lone occupant, Virgil Brown, a farmer who lived down the side road less than a mile, lay unconscious in one corner of the pick-up. While I raced back to my truck to give details, Ruenger had heard the call on his CB while traveling home from we needed a doctor and ambulance fast. While relaying our location, two other cars had stopped (one of the cars had heard the call on his CB while traveling home from work) they had blankets and were giving first aid to the victim who was to remain unconscious for several days. In less than 15 minutes a doctor, ambulance and traffic patrol were on the scene.

"The victim remained in serious condition for 13 days after which he remained in the hospital for two months. The doctors reported that all his ribs had been broken and one lung collapsed, but being able to get medical help as fast as we did with our CB radio saved his life and this man will be able to live a normal life.

"Sometime later I learned that the victim, Virgil Brown, had seen my truck but was unable to avoid sliding through the stop sign into my path.

Yours truly,

Jon C. Lueck

Box 36, Kingston, Wisconsin"

### WIN A COMPANION II CB

Your story of "CB in Action" can win a COMPANION II CB. Write and tell us how CB helped perform a service or helped you or your community in an emergency. Send your story to Les Hench, National Sales Manager, PEARCE-SIMPSON, INC., P.O. Box 800, Biscayne Annex, Miami, Florida 33152.





## advertisers index

American Knitwear .....	13
Amphenol-Borg Electronics Corp. ....	31
Antenna Specialists Co. ....	Cover 2
Apollo Co. ....	27
Astro Antenna Corp. ....	34
Bonanza .....	24
Browning Laboratories, Inc. ....	6
Channel 9 Decal .....	52
e.c.i. electronics communications, inc. ....	38, 39
Eico Electronic Instrument Corp. ....	3
General Radiotelephone Corp. ....	Cover 4
Hallicrafters Co. ....	37
Heath Company .....	11
Hy-Gain Antenna Products .....	Cover 3
International Crystal Mfg. Co. ....	1, 26
Johnson, E. F. Co. ....	5
Kaar Engineering .....	49
King of the Band .....	72
Knights, C. T. S., Inc. ....	31
Knox Electronics .....	34
Lafayette Radio .....	35
Master Mobile Mounts .....	48
Mathews QSL's .....	27
Mosley Electronics .....	40, 41
Multi-Elmac Co. ....	58
New-Tronics Corp. ....	29
Pace Communications Corp. ....	45
Pearce-Simpson, Inc. ....	52, 73
Petersen Radio Co., Inc. ....	46
Poem .....	61
Project Aid .....	75
RCA .....	8
RC Enterprises .....	58
Simon Side Band Co. ....	27
Sonar Radio Corp. ....	55
Sonotone Corp. ....	51
Squires-Sanders, Inc. ....	50
Technics, Inc. ....	67
Texas Crystals .....	13
Tram Electronics .....	22
United Scientific Labs .....	19
World Radio Labs .....	76
Who's Who .....	20

"Souvenir Coins" First and second annual jam-boree "Grandfather Mountain," Asheville 10-4 CB Club, 611 Irwin Ave., Spartanburg, S. C. 25¢ for both coins plus free warning sticker.

CB-QSL's—200 designs, humorous, regular, state maps. Free bonus card. Catalogues—samples 25¢, KCJ1955, Lile Guill, Rustburg, Virginia 24588.

CB-QSL's . . . 18 Samples 10¢ . . . Filmcrafters . . . Martins Ferry, Ohio 43935.

SELL: Tram TR70C 6/12 VDC 23 Channel Mobile, Excellent Condx \$185.00, Ken—WA9OQE, 708 S. 5th St., Marshall, Ill. 62441.

Crystals Guaranteed any channel—most sets \$1.99 ea. \$3.80 pr. cash with order shipped postpaid radios and accessories. Crystal King, Box 439, Big Rapids, Michigan.

CB Catalog—Fantastic Bargains—Write Echo Communications, Box 43, Cedarburg, Wisconsin 53012.

FREE SAMPLES—CB QSL CARDS—\$2.50 per 100 in 3 colors. Garth Printing Company, Box 51S, Jutland, New Jersey.

CB-QSL's, 200 designs, state maps, humorous, regular. Catalog-samples 25¢ (refunded). KCJ1955, Lile Guill, Rustburg, Va. 24588.

No Others Like Them! Sparkling 3-D Cards in space-age designs for QSL — CBL — WPE use. New 3-D Christmas designs, personalized greetings. Samples 25¢ (refundable). 3-D QSL Co., Monson 3, Mass. 01057.

"LOUDMOUTH" Mike pre-amp—smaller than a penny match box, mounts internally in all CB transceivers, make your station sound like a kilowatt. Specify type of unit, wired and tested, instructions furnished. Postpaid, \$15.00. Carroll Electronics, 3175 Barron, Memphis, Tennessee 38111.

CB transmitters \$6.00. Other bargains, catalog 10¢. Vanguard, 190-48—99th Ave., Hollis, New York 11423.

Crystals—CB—Sub-Miniature types in HC—18/U holders. Used in Walkie-Talkies and other sets. Only \$1.50 each postpaid these exceed FCC tolerances. Send for list of available channels. Quaker Electronics, Hunlock Creek, Pa. Known Worldwide for my quality crystals.

NUSSBAUM'S FOLLY! The printer goofed on our last order and ran off 3 times the amount of our famous wild CB QSL cards than we wanted. We refused to pay for the extras and can now pass these savings on to you. You never saw cards of this quality at 175 for only \$1. All you do is add your name and call signs and they look better than cards costing many times this price. Order; enjoy, enjoy. S. Nussbaum, 1440 50th St., Brooklyn, N. Y.

WANTED: Knight KN2553 Channel Sentries—\$15 each if working. Box 685, Independence, Missouri.



NAMETAGS, your name and call, club engraved on plastic/formica, Two lines—\$1.35. One line—\$1.15. Wide choice of color, sizes, write for Big Club Discount and sample on club letterhead. D-Lux Engraving, Box 2, Bellevue, Nebraska.

Not enough audio? Write for free literature on the miniature preamp and clipper-filter. Both transistor units are self-powered and require no connections inside unit. From \$10.95. Dept. S65, J-A Electronics, Box 645, Teaneck, N. J.

"U.S. GOVERNMENT OFFICIALLY LICENSED RADIO COMMUNICATION STATION" sign for your sun visor. Printed in big white letters on black background, heavy card stock. Looks great! Order it now and receive absolutely FREE a realistic "UNCLE" ID card and a zany surprise sticker for your front door. Only 50¢, 3 sets for \$1, postpaid. Haral Associates, CB Dept., 1133 Broadway, New York, N. Y. 10010.

FREE S9 SUBSCRIPTION with each and every one of our TR-SONIC FISH CALLS. Sold in stores at \$13.95, we'll let you have one (with 12 issues of S9) for only \$11.95 if you mention that you saw our ad here. In the ocean, in a river or lake, this device attracts fishes by means of electronic trickery. Comes with batteries, ready to pull 'em in. Electronics, P.O. Box 124, Jamaica 13, N. Y.

QSL's-CB . . . 18 samples 10¢ . . . Filmcrafters . . . Martins Ferry, Ohio 43935.

C. FRITZ for the best in CB QSL's! Samples 25¢ deductible. Box 1684, Scottsdale, Arizona.

CB transmitters \$6.00. Other bargains, catalog 10¢. Vanguard, 190-48 99th Ave., Hollis, N. Y. 11423.

CRYSTALS, Mailed anywhere. Any channel, any set, all \$2.25 each. Thousands in stock. Shipped same day. Cash orders shipped postpaid. Worcester Radio, 164 Main Street, Worcester, Mass. 01608.

NAMEPLATES, decals, tags, signs and labels. Free samples. Seton Corp., Dept. CBJ, New Haven, Conn. 06515.

HEY PUSSY CATS! Want a sneaky way to build up your card swappers collection? We will ship you 25 different cards for only \$1. No printers samples or junk, but REAL CB QSL's from all over, some actually signed by the ops. S. Nussbaum, 1440 50th St., Brooklyn, N. Y. 11219.

I-C-B-A. A non-profit Ass'n. for Citizens Radio Clubs, Members, Business and Individuals. Clubs—\$10, Active—\$5, Semi-Active—\$3. (Not restricted-Inactive \$1, year) Memberships available. Majority will succeed—not Minority in Congress or FCC Bureaus. Join now, enjoy prestige, recognition the American way. Registered with the California Secretary of State since Feb. 17, 1965. I-C-B-A, Box 464-90231, Culver City, Calif.

CB SPORTSMEN! The famous TR-SONIC FISH CALL — brings the fish right to your hook in fresh or salt water. Sold nationally for \$13.95, only \$8.95 to S9 readers. Complete with batteries. Custom Electronics Co., 2929 Fulton Street, Brooklyn 7, N. Y. Say you saw it in S9.

## FCC EMERGENCY NOTIFICATION CARDS ONLY 2¢ EACH!

Section 95.85(1) of the CB rules states that if you use your CB gear for any emergency, even for calling for help for a stranded motorist, you must notify (in writing) both the FCC in Washington and your local FCC office. You must do this for each time you use your CB rig for emergencies. These FCC Notification cards were specifically designed to cut to a minimum the paperwork necessary for well meaning clubs and individuals—they contain all of the necessary wording (and are even addressed)—all you do is fill in a few blanks, stamp, and drop into the nearest mailbox. They come with a list of addresses of local FCC offices. Available postpaid in packages of 50 for only \$1. Thousands of these cards are already in circulation. Order now from:

**Project Aid  
S9 Magazine  
14 Vanderventer Avenue  
Port Washington, N. Y. 11050**

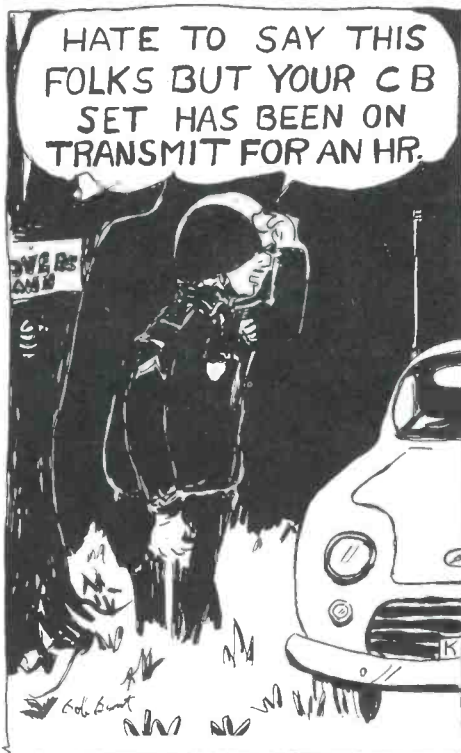



Leo I. Meyerson  
KLH 7297

# THIS NEW DELUXE CB TRANSCEIVER PUTS YOU ON THE AIR IN SECONDS!

**COMPLETE  
NO EXTRAS  
TO BUY!**

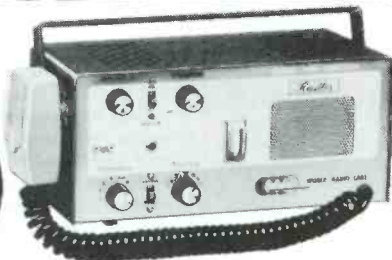

PRICE INCLUDES:  
Both AC/DC Supply &  
Mounting Bracket.

**\$79<sup>95</sup>**

Made in  
U.S.A.

**\$5.00 Monthly**

## NEW! WRL'S "RUSTLER" CB TRANSCEIVER

Here's a New *Deluxe* American Made CB Transceiver with features you would expect to find only in CB units costing much more. *WRL's Rustler CB Transceiver* is a complete package with 115 VAC and 12 volt DC power supply, cords, mtg. bracket and PTT mike. It also includes eight crystal-controlled channels and a 23 channel, tunable, super-het receiver. (CRYSTALS FOR CH. 9 SUPPLIED)

Other important features include a positive squelch control, illuminated "S" meter, spotting switch, ANL, 3.4 watts, and a quick-change crystal socket. Beautifully designed for home or auto use! Only WRL offers you the finest for less.

### CB WALKIE-TALKIE Exclusives from WRL

#### 3 TRANSISTOR



**\$9<sup>95</sup>** WIRED  
ea. in pairs

- Ready to operate.
- No license needed — No age limit.
- Operates on single battery.
- Handsome - Compact Weighs 10 oz.

On the move communications. Range 1/4 mile and more — ideal conditions.

#### 9 TRANSISTOR



**\$24<sup>95</sup>** WIRED  
ea. in pairs

- Range - 1-3 miles.
- Crystal controlled.
- Noise limiter switch.
- Push-to-talk switch.
- Leather case, earphone.

Ideal For Business, Pleasure & Home Use.

#### ONE WATT



**\$59<sup>95</sup>** WIRED  
ea. in pairs

- Professional Model.
- Range - 1-5 miles.
- FCC License required.
- 13 Transistors.

#### WRL'S CB PRE-AMPLIFIER

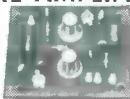

**\$1195 each**  
Improves any CB receiver . . .

Guaranteed to improve CB reception. Uses two 6CW4 nuvistors providing up to 20DB gain on receiver signals.  
**READY-TO-INSTALL**

## WRL

WORLD RADIO LABORATORIES  
3415 West Broadway  
Council Bluffs, Ia. 51504

Please Rush Me

WRL's Rustler CB Transceiver.  3 Transistor Walkie-Talkie, \$9.95 ea. in pairs.  9 Transistor Walkie-Talkie, \$24.95 ea. in pairs.  1 Watt Walkie-Talkie, \$59.95 ea. in pairs.  WRL's CB Pre-amplifier, \$11.95.  Compression Amplifier, \$14.95.

Name \_\_\_\_\_

Address \_\_\_\_\_

City \_\_\_\_\_ State \_\_\_\_\_ Zip \_\_\_\_\_

#### NEW COMPRESSION AMPLIFIER

Made in  
U.S.A.



**\$1495**

A True Compressor  
Not a Clipper

- CB/HAM/COMMERCIAL USE
- Provides up to 15DB Compression.
- New Low Price
- Quantity Prices Available

# Extend your "Talk Power"

with

## Hy-Gain's **CLR2**

the world's most powerful all-directional,  
non-rotating base station antenna  
for Citizens Band

**With a Hy-Gain CLR2, your 5-watt  
transceiver delivers power in all directions  
equivalent to what you'd get with a  
12.55 watt rig.**

**That's "Talk Power!"**

For maximum range and greatest reliability in your communications, Hy-Gain's CLR2 is the one all-directional, non-rotating antenna that is built to do the job. It is loaded with electrical and mechanical features that clearly put it in a class all of its own. Take for example the electrically extended 5/8 wavelength vertical radiator. Here we're talking basics but they're vitally important basics. In test after test conducted by every authoritative source in the electronics field, a 5/8 wavelength radiator has conclusively proven to deliver a stronger signal over a greater area than either a 1/4 wavelength or 1/2 wavelength radiator. The chart graphically shows how power wasted in the atmosphere by 1/4 wavelength and 1/2 wavelength radiators is concentrated into a lower, more extended

arc close to the horizon by a 5/8 wavelength radiator thus providing a stronger signal over a greater area.



What else does the CLR2 have that makes it deliver maximum "Talk Power"? It has the original static-removing "Top Hat" that drastically cuts receiver noise...a moisture-proof matcher that insures total electrical reliability...a unique electrical system that puts the entire antenna at DC ground for maximum static removal and lightning protection... rugged, heavy duty, all-weather construction, rated to withstand winds up to 100 mph. For maximum "Talk Power"—greatest readability—you'll want a CLR2...a bargain in power at \$29.95 Net.

Available from your Hy-Gain Dealer or Distributor

**HY-GAIN ELECTRONICS CORPORATION**  
8450 N.E. Highway 6—Lincoln, Nebraska 68501



Once again General has produced a new and original design to set the pace for the entire Citizens Radio Industry. The new 24 Channel Super MC-8 with Turretuner® is years ahead of the field. Its 30 watt construction, with 100% modulated double sideband transmitter and super sensitive dual conversion receiver are the result of many years of development and testing.

Move up to the professional level in CB radio. Try this outstanding unit at your General Dealer today or write General for complete technical manual and schematic.

## General 24 Channel Super MC-8 \$199<sup>50</sup>

Complete with microphone, 110 V AC cord, 1 transmit/receive crystal, Channel 11; and instruction manual



### GENERAL RADIOTELEPHONE COMPANY

3501 West Burbank Boulevard, Burbank, California

Telephone: 849-6891, Area Code: 213

# WIN

A 615-B  
MULTIFUNCTION  
BRIDGE



FREE IN GENERAL'S  
MONTHLY DRAWING!

October Winner

Dale B. Schearer, KH18560, Dayton, Ohio

Name \_\_\_\_\_ CB  
Call \_\_\_\_\_  
Address \_\_\_\_\_ Ham  
Call \_\_\_\_\_  
City \_\_\_\_\_ State \_\_\_\_\_  
My CB Dealer is \_\_\_\_\_  
Dealer's Address \_\_\_\_\_  
City \_\_\_\_\_ State \_\_\_\_\_

My CB Club is \_\_\_\_\_  
Club Address \_\_\_\_\_  
City \_\_\_\_\_ State \_\_\_\_\_

**Good for December drawing ONLY. (\$9)**

Under present rules part 19.32 the FCC does not provide for more than 5 watt input in the Citizens Radio Service (26.965-27.225 MC Band).



14 Vanderventer Ave.  
Port Washington, L. I., N. Y.

Controlled Circulation Postage Paid at New York, N. Y.

